



Market Leading Portfolio of
Ophthalmic Surgical Devices

Table of Contents

Safety Knives	5
Safety Knives.....	6
Conventional Knives.....	8
Mini-Blades	11
Grindless Beaver® Mini-Blades.....	12
Blades.....	13
Trepines.....	14
Handles and Accessories.....	15
Handles and Accessories Chart	16
Cannulas	17
Anesthesia Cannulas.....	18
Anterior Chamber Cannulas.....	19
Anterior Chamber Maintainers.....	20
Hydrodissection Cannulas	21
Cystotome Cannulas.....	24
Irrigation Cannulas	26
Irrigation and Aspiration Cannulas	26
Polishers	28
Glaucoma Revision Picks	29
Lacrimal Cannulas	30
Refractive and FLACS	31
Other	32
Hubs	32
Single-Use Instruments	33
Adjustable Speculums	34
Sprung Speculums	34
Pediatric Speculums.....	36
Fixation Forceps - Toothed.....	36
Fixation Forceps - Notched.....	37
Capsulorhexis Forceps.....	38
General Forceps.....	39
IOL Forceps	40
Tying Forceps.....	40
Choppers	41
Manipulators.....	42
Dissection Scissors	44
Dressing Scissors.....	44
Sprung Scissors	45
Dressing Forceps.....	46
Needle Holders and Drivers.....	46
Flap Elevators and Separators	47
Epithelium Spatulas, Hoes and Wells.....	49
Lacrimal Intubation CIS.....	49
Markers, Gauges and Calipers	50
Probes and Dilators.....	51
Clamps and Curettes	52
Fixation Rings	52
Small Pupil Expansion	53
I-Ring® Pupil Expander.....	54
Fluid Control.....	55
PVA Eye Spears.....	56
Corneal Light Shields.....	57
Full Body Drapes	58
Half Body Drapes	59
Face Drapes.....	61
Drape Accessories.....	63
Eye Drains	63
Instrument Wipes	64
Other Fluid Control.....	64
Accessories	65
Eye Shields and Bandages	66

Custom Packs	68
Electrosurgery and Electrocautery	71
Cautery Devices.....	72
Erasers.....	73
Dry Eye	75
Permanent Occlusion.....	76
Partial Occlusion.....	77
Single-Use Punctal Dilators and Probes.....	77
Other Related Occlusion Options.....	78
Malosa® Single-Use Packs	79
Phaco Packs.....	80
Refractive Packs.....	80
Corneal Packs.....	81
IVT Packs.....	81
Oculoplastics Packs.....	82
Chalazion Packs.....	84
Blepharoplasty Packs.....	84
Sub Tenons Pack.....	85
Retinal Packs.....	85
IOL Portfolio	87
Trifocal Toric Hydrophobic.....	88
Trifocal Toric Hydrophilic.....	89
Trifocal Hydrophobic.....	90
Trifocal Hydrophilic.....	91
Premium Monofocal.....	93
Monofocal Toric Hydrophobic.....	94
Monofocal Toric Hydrophilic.....	95
Preloaded Monofocal Hydrophobic.....	96
Monofocal Hydrophobic.....	97
Product Families.....	99
Product Categories.....	100
Toric Calculator.....	102
Equipment and Instruments	103
Endo Optiks®.....	104
Endo Optiks® Accessories.....	105
Surgical Equipment.....	107
Accessories for Cataract and Cataract/Vitreoretinal Equipment.....	109
Accessories for Cryo-surgery Equipment.....	110
Procedure Packs.....	111
Other Devices for Irrigation/Aspiration for Cataract and Vitreoretinal Surgery.....	114
Stand Alone Devices and Kits.....	115
Reusable Devices for Surgical Equipment.....	118
Diagnostic Equipment and Accessories for Corneal Topography.....	120
Accessories for Ultrasound Diagnostics.....	122
Vitreoretinal	123
Directional Chandelier.....	123
Micro Forceps and Scissors.....	125
90° Directional Laser Probes.....	129
Backflush Instruments.....	131
Light Fibers.....	135
Vitreoretinal Consumables.....	137
Liquids and Gases	143
OVDs.....	144
Saline Solutions.....	144
Surgical Dyes.....	145
Tamponade Agents.....	145
Corneal Protection.....	147
Product Index	148

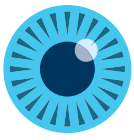

BVI

High Quality, Single Handed Safety Activation Knives

Sharpness | Consistency | Safety



Options for Crescent,
MVR, Sideport and Slit

Safety Knives

Safety Slit Knives

Safety Slit Knives are available in a wide range of sizes designed for penetration and accurate incision width.



378222

Single Bevel

Qty: 10/Bx
Brand: Beaver®

Description	SKU #
1.4 mm Slit, Angled, Single bevel	378214
1.5 mm Slit, Angled, Single bevel	378215
1.8 mm Slit, Angled, Single bevel	378218
2 mm Slit, Angled, Single bevel	378220
2.2 mm Slit, Angled, Single bevel	378222
2.4 mm Slit, Angled, Single bevel	378224
2.5 mm Slit, Angled, Single bevel	370145
2.6 mm Slit, Angled, Single bevel	370146
2.75 mm Slit, Angled, Single bevel	378227
2.8 mm Slit, Angled, Single bevel	378228
3 mm Slit, Angled, Single bevel	378230
3.2 mm Slit, Angled, Single bevel	378232



378822

Double Bevel

Qty: 10/Bx
Brand: Beaver®

Description	SKU #
2 mm Slit, Angled, Double bevel	378820
2.2 mm Slit, Angled, Double bevel	378822
2.4 mm Slit, Angled, Double bevel	378824
2.5 mm Slit, Angled, Double bevel	378825
2.65 mm Slit, Angled, Double bevel	378826
2.75 mm Slit, Angled, Double bevel	378827
2.8 mm Slit, Angled, Double bevel	378828
2.85 mm Slit, Angled, Double bevel	378829
3 mm Slit, Angled, Double bevel	378830
3.2 mm Slit, Angled, Double bevel	378832

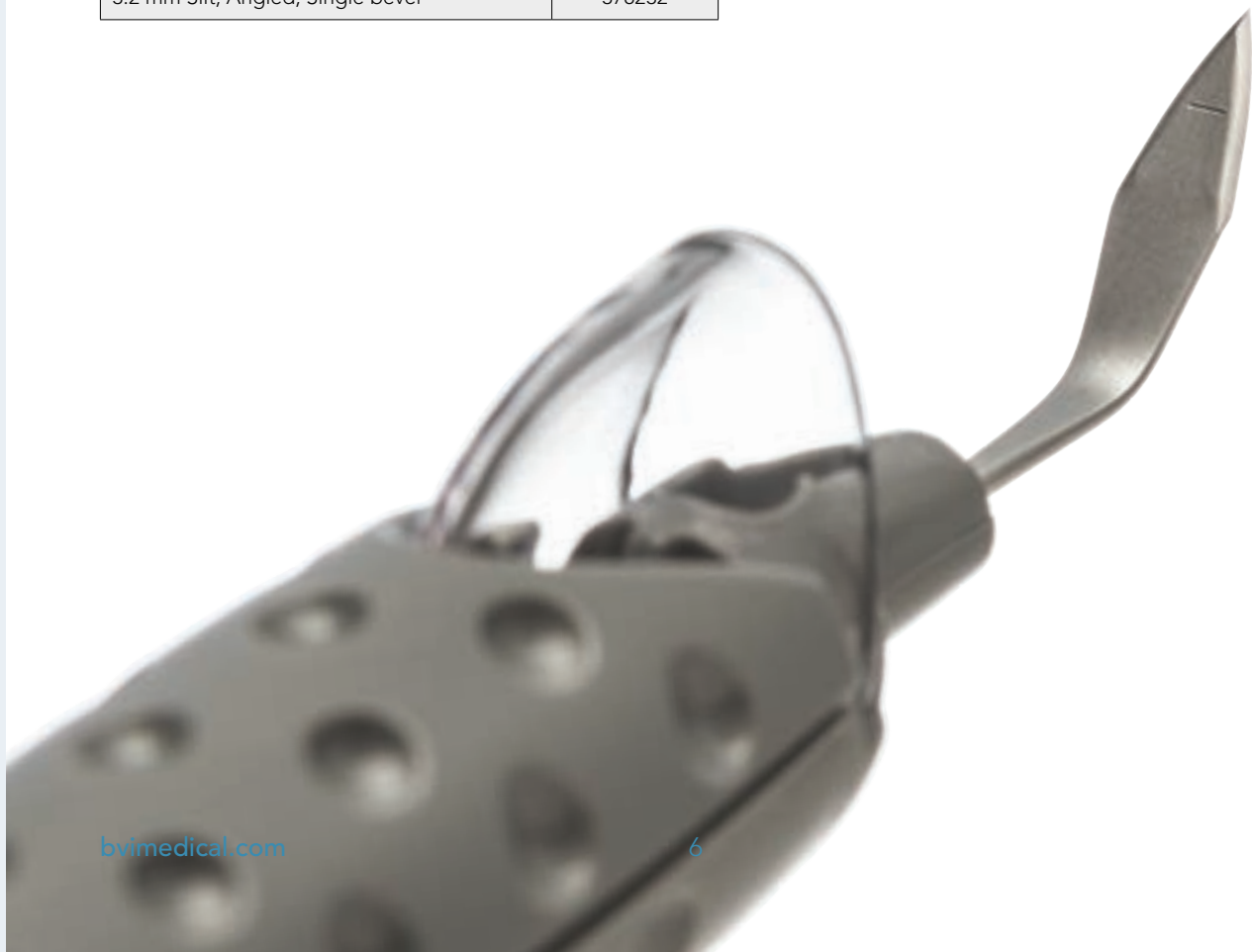

Safety Knives

Safety Crescent Knives

Safety Crescent Knives are angled 55 degrees with the bevel up, designed for optimal tunnel architecture.



378234

Qty: 10/Bx
Brand: Beaver®

Description	SKU #
2.5 mm Crescent, 55 Degrees, Bevel up	378234

Optimum Safety Sideport Knives

Safety Sideport Knives are designed for stab incisions.



378235

Qty: 10/Bx
Brand: Beaver®

Description	SKU #
15 Degree Sideport, Straight	378235
22.5 Degree Sideport, Straight	378236
30 Degree Sideport, Straight	378237
45 Degree Sideport, Straight	378238

Safety Sideport Knives

Safety Sideport Knives are designed for accurate width stab incisions.



378212

Qty: 10/Bx
Brand: Beaver®

Description	SKU #
1 mm Sideport, Angled 45 degrees	378210
1.2 mm Sideport, Angled 45 degrees	378212
0.6 mm 23G Sideport MVR	378233
1.15 mm 20G Sideport, Angled 45 degrees	378231

Kojo Safety Slit Knives

Kojo Safety Slit Knives are slit blades with an arcuate shape.



373025

Qty: 10/Bx
Brand: Beaver®

Description	SKU #
2.5 mm Kojo Slit, 45 Degrees, Arc height is 0.55 mm	373025
3.2 mm Kojo Slit, 45 Degrees, Arc height is 0.71 mm	373032

Conventional Knives

Slit Knives

Slit Knives are available in a wide range of sizes designed for penetration and accurate incision width.



373727

Single Bevel

Qty: 10/Bx
Brand: Beaver®

Description	SKU #
1.8 mm Slit, 45 Degrees, Single bevel up	373718
2.2 mm Slit, 45 Degrees, Single bevel up	373722
2.4 mm Slit, 45 Degrees, Single bevel up	373724
2.5 mm Slit, 45 Degrees, Single bevel up	373725
2.6 mm Slit, 45 Degrees, Single bevel up	373726
2.75 mm Slit, 45 Degrees, Single bevel up	373727
2.8 mm Slit, Straight, Matte	373328
2.8 mm Slit, 45 Degrees, Single bevel up	373728
3 mm Slit, 45 Degrees, Single bevel up	373730
3.2 mm Slit, Straight, Matte	373332
3.2 mm Slit, 45 Degrees, Single bevel up	373732



370824

Double Bevel

Qty: 10/Bx
Brand: Beaver®

Description	SKU #
2 mm Slit, 45 Degrees, Double bevel up	370820
2.2 mm Slit, 45 Degrees, Double bevel up	370822
2.4 mm Slit, 45 Degrees, Double bevel up	370824
2.5 mm Slit, 45 Degrees, Double bevel up	370825
2.65 mm Slit, 45 Degrees, Double bevel up	370826
2.75 mm Slit, 45 Degrees, Double bevel up	370827
2.8 mm Slit, 45 Degrees, Double bevel up	370828
3 mm Slit, 45 Degrees, Double bevel up	370830

Crescent Knives

Crescent Knives offer the flexibility to create optimal tunnel architecture. Available in straight, bevel up or bevel down.



373809

Qty: 10/Bx
Brand: Beaver®

Description	SKU #
2.5 mm, 55 Degrees, Bevel up	373807
2.5 mm, 55 Degrees, Straight	373808
2.5 mm, 55 Degrees, Bevel down	373809

Sideport Knives

Sideport Knives are designed for accurate width stab incisions.



373712

Qty: 10/Bx
Brand: Beaver®

Description	SKU #
1 mm Sideport Knife, Angled	373710
1.2 mm Sideport Knife, Angled	373712

Conventional Knives

EdgeAhead Sideport and MVR Knives



585232

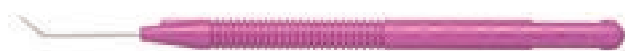

376620



376630

Qty: Various/Bx
Brand: Beaver®

Description	SKU #
0.6 mm Stiletto, 5/Bx	585232
0.6 mm MVR, Straight, 5/Bx	585231
1.1 mm MVR, Straight, 5/Bx	585240
1.15 mm MVR, 20G, Straight, 10/Bx	376630
1.15 mm Sideport, Angled, 10/Bx	376620

Sclerotome Knife



The Sclerotome knife has a smaller cutting edge than the Sclerotome blade (375700) and is designed to have a more precise, controlled dissection.



Qty: 10/Bx
Brand: Beaver®

Description	SKU #
Multi sided sharp all around	375701

Mini-Blade Knife



Qty: 10/Bx
Brand: Beaver®

Description	SKU #
Surgical blade, 180 Degree cutting surface	374769



Conventional Knives

Optimum Knives



Optimum Knives are color coded for identification. Offered in a wide range of sizes.



374890



374891



374892



374893



374894

Qty: 10/Bx
Brand: Beaver®

Description	SKU #
15 Degrees, 30 Degree bend left	374890
15 Degrees, Straight, Green	374891
22.5 Degrees, Straight, Slate blue	374892
30 Degrees, Straight, Black	374893
45 Degrees, Straight, Tan	374894

Micro-Unitome Knives



Micro-Unitome Knives are manufactured using a proprietary grindless technology to support a more consistent sharpness. Each knife is color coded for identification.



377512



377514



377516



377523



377531



377546

Qty: 10/Bx
Brand: Beaver®

Description	SKU #
1.5 mm, 15 Degrees, Orange	377512
3 mm, 15 Degrees, Blue	377514
5 mm, 15 Degrees, Green	377516
4 mm, 22.5 Degrees, Light blue	377523
3.5 mm, 30 Degrees, Black	377531
3 mm, 45 Degrees, Tan	377546



Mini-Blades

Available in a variety of designs to meet all small incision and excision needs.

Mini-Blade



Qty: 6/Bx
Brand: Beaver®

Description	SKU #
Sharp on two sides with pointed tip	376300

Mini-Blade

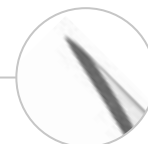

Qty: 24/Bx
Brand: Beaver®

Description	SKU #
Pointed tip, Smaller alternative to #11 general blade	376500

Mini-Blade



Qty: 24/Bx
Brand: Beaver®

Description	SKU #
MIS 6400, Narrower version of Beaver6400 for minimally invasive surgery	376401

Sclerotome Blade

The Sclerotome is a versatile blade suitable for glaucoma and retinal procedures.



Qty: 3/Bx
Brand: Beaver®

Description	SKU #
Multi sided sharp all around S/Su	375700



Grindless Beaver® Mini-Blades

BVI's Mini-Blades are manufactured using a proprietary grindless technology and are designed to meet all small incision and excision needs. Mini-Blades are preassembled into a unique, patented tip, designed for safe assembly. Each Mini-Blade is color coded for identification.

6400 Mini-Blade

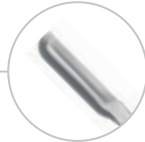

Qty: 20/Bx
Brand: Beaver®

Description	SKU #
Rounded tip, Sharp on one side, Green	BEAVER6400

6700 Mini-Blade



Qty: 20/Bx
Brand: Beaver®

Description	SKU #
Smaller alternative to #15 general blade, Orange	BEAVER6700

6600 Mini-Blade



Qty: 3/Bx
Brand: Beaver®

Description	SKU #
Lamellar, Angled 60 degrees, Smooth undersurface, Sharp all around, Bevel up, Black	BEAVER6600

6900 Mini-Blade



Qty: 20/Bx
Brand: Beaver®

Description	SKU #
Straight, Sharp all around, 180 Degree cutting surface, Double bevel blade, Blue	BEAVER6900

6610 Mini-Blade



Qty: 3/Bx
Brand: Beaver®

Description	SKU #
Lamellar, Straight, Smooth undersurface, Sharp all around, Black	BEAVER6610

Blades

Micro-Sharp® Blades

Micro-Sharp Blades are manufactured using a proprietary grindless technology. Each blade is color coded for identification.

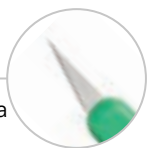

377511



377513



377515



377522



377530



Qty: 6/Bx
Brand: Beaver®

Description	SKU #
1.5 mm, 15 Degrees, Orange	377511
3 mm, 15 Degrees, Blue	377513
5 mm, 15 Degrees, Green	377515
4 mm, 22.5 Degrees, Light blue	377522
3.5 mm, 30 Degrees, Black	377530

Optimum Blades

Optimum stab blades are color coded for identification. Offered in a wide range of sizes.



374881



374882



374883



Qty: 5/Bx
Brand: Beaver®

Description	SKU #
15 Degrees, Straight, Green	374881
22.5 Degrees, Straight, Slate blue	374882
30 Degrees, Black	374883



Trephines

Trephine Blades are handcrafted with a sharp, uniform cutting edge, designed for a precise, symmetrical cut of the corneal layers.

Overall length 15.8 mm and provided sterile for single-use.



Qty: 1/Bx
Brand: Beaver®

Description	SKU #
4 mm Trephine Blade	9550026
5 mm Trephine Blade	0009701
5.5 mm Trephine Blade	0009703
6 mm Trephine Blade	0009705
6.25 mm Trephine Blade	0009706
6.5 mm Trephine Blade	0009707
6.75 mm Trephine Blade	0009708
7 mm Trephine Blade	0009709
7.25 mm Trephine Blade	0009719
7.5 mm Trephine Blade	0009711
7.75 mm Trephine Blade	0009722
7.85 mm Trephine Blade	0009710
8 mm Trephine Blade	0009713

Description	SKU #
8.25 mm Trephine Blade	0009727
8.5 mm Trephine Blade	0009715
8.75 mm Trephine Blade	0009723
9 mm Trephine Blade	0009717
9.25 mm Trephine Blade	9550025
9.5 mm Trephine Blade	9550005
10 mm Trephine Blade	0009721
10.5 mm Trephine Blade	9550006
11 mm Trephine Blade	0009725
11.5 mm Trephine Blade	9550013
12 mm Trephine Blade	9550028
13 mm Trephine Blade	9550029
14 mm Trephine Blade	0009728

Handles and Accessories

Handles

Stainless steel handles are available in round and hex configurations, in a variety of lengths.

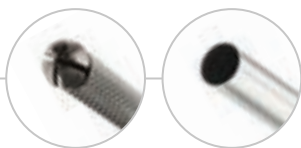

371395



374320



374340



375000

Type: Reusable

Qty: 1/Bx
Brand: Beaver®

Description	SKU #
Round handle, 13 cm Long x 0.5 cm Diameter	371350
Round handle, 13 cm Long x 0.66 cm Diameter	371360
Round handle, 18 cm Long x 4 mm Diameter with wrench	371394
Round handle, 21 cm Long x 4 mm Diameter with wrench	371395
Round handle, 10 cm Long x 0.66 cm Diameter	371410
Flat handle, 17 cm Long	372000
Round handle, 10 cm Long x 0.5 cm Diameter	374310
Round handle, 7.5 cm Long x 0.5 cm Diameter	374312
Round handle, 15.5 cm Long x 0.5 cm Diameter	374320
Hex handle, 10 cm Long x 0.5 cm Diameter	374330
Hex handle, 15.5 cm Long x 0.5 cm Diameter	374340
Flat handle, 13 cm Long 1 cm Wide	375000

Wrenches and Collets

All wrenches and collets are stainless.



371301



371305

Qty: 1/Bx
Brand: Beaver®

Description	SKU #
Blade wrench	371301
Collet replacement, 0.5 cm Diameter	371305

Handles and Accessories

BLADES	HANDLES									REPLACEMENT COLLET
	371350	371360	371394	371395	374310	374312	374320	374330	374340	371305
Beaver6400	x	x	x	x	x	x	x	x	x	
Beaver6600	x	x	x	x	x	x	x	x	x	
Beaver6610	x	x	x	x	x	x	x	x	x	
Beaver6700	x	x	x	x	x	x	x	x	x	
Beaver6900	x	x	x	x	x	x	x	x	x	
Beaver6910	x	x	x	x	x	x	x	x	x	
375435	x	x			x	x	x	x	x	x
375450	x	x			x	x	x	x	x	x
375700	x	x			x	x	x	x	x	x
376300	x	x			x	x	x	x	x	x
376401		x			x	x	x	x	x	x
376500	x	x			x	x	x	x	x	x
377511	x	x			x	x	x	x	x	
377513	x	x			x	x	x	x	x	
377515	x	x			x	x	x	x	x	
377522	x	x			x	x	x	x	x	
377530	x	x			x	x	x	x	x	



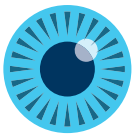

BVI

40 Years of Innovation and Quality Cannulas

Supporting All Areas of Ophthalmic Surgery

- A market leader of ophthalmic cannulas for over 40 years
- Full range of single-use cannulas developed to support all ophthalmic surgical procedures
- A history of innovation to meet your diverse surgical needs



Anesthesia Cannulas

Retrobulbar (Atkinson)

Intended for injecting anaesthetic agents into the muscle cone.



581637

Qty: 10/Bx
Brand: Visitec®

Description	SKU #
● 23G x 1-1/2 in, 0.6 x 38 mm	581638
● 25G x 1-1/2 in, 0.5 x 38 mm	581637

Retrobulbar/Peribulbar (Atkinson)



585001

Qty: 10/Bx
Brand: Visitec®

Description	SKU #
● 23G x 1-1/4 in, 0.6 x 32 mm	585001
● 25G x 1-1/4 in, 0.5 x 32 mm	585108
● 27G x 1-1/4 in, 0.4 x 32 mm	585109

Peribulbar (Atkinson)

Intended for injecting anaesthetic agents around the globe (periocular).



585144

Qty: 10/Bx
Brand: Visitec®

Description	SKU #
● 23G x 7/8 in, 0.6 x 22 mm	585144
● 25G x 7/8 in, 0.5 x 22 mm	585027
● 27G x 7/8 in, 0.4 x 22 mm	585145

Retrobulbar (Sharp Atkinson)



581641

Qty: 10/Bx
Brand: Visitec®

Description	SKU #
● 25G x 1-1/2 in, 0.5 x 38 mm	581641

Retrobulbar (Sharp Point)

Intended for injecting anaesthetic agents into the muscle cone.



581275

Qty: 10/Bx
Brand: Visitec®

Description	SKU #
● 25G x 1-1/2 in, 0.5 x 38 mm	581275

Retrobulbar, Curved (Atkinson/Straus)

Designed to course around the globe and enter the anterior region of the muscle cone inferotemporal and parallel to the optic nerve. Straight portion 11 mm, curved portion 22 mm.



585019

Qty: 10/Bx
Brand: Visitec®

Description	SKU #
● 25G x 1-3/8 in, 0.5 x 34 mm	585019

ISO Hub Gauge Chart

*BVI Gauge Color Chart Located on Page 32.

19G	20G	21G	22G	23G	24G	25G	26G	27G	30G
-----	-----	-----	-----	-----	-----	-----	-----	-----	-----

Anesthesia Cannulas

Sub-Tenon's Anesthesia Cannula

Intended for administering anaesthetic agents into the posterior sub-tenon's space.



585176

Qty: 10/Bx
Brand: Visitec®

Description	SKU #
● 19G x 1 in, 1.1 x 25 mm	585176

Anterior Chamber Cannulas

Intended to be used for irrigation/injection of liquid.

Anterior Chamber (Rycroft)

Angled 45 degrees, 4 mm from end.



585025

Qty: 10/Bx
Brand: Visitec®

Description	SKU #
● 21G x 7/8 in, 0.8 x 22 mm	581281
● 23G x 7/8 in, 0.6 x 22 mm	585025
● 25G x 7/8 in, 0.5 x 22 mm	581639
● 27G x 7/8 in, 0.4 x 22 mm	581280
○* 30G x 7/8 in, 0.3 x 22 mm	581273

Anterior Chamber Cannula

Angled 45 degrees, 6 mm from end.



581284

Qty: 10/Bx
Brand: Visitec®

Description	SKU #
● 25G x 7/8 in, 0.5 x 22 mm	581642
● 27G x 7/8 in, 0.4 x 22 mm	581284
○* 30G x 7/8 in, 0.3 x 22 mm	581285

Anterior Chamber Cannula Straight



585006

Qty: 10/Bx
Brand: Visitec®

Description	SKU #
● 27G x 7/8 in, 0.4 x 22 mm	585006

Anterior Chamber Maintainers

Self Retaining ACM (Lewicky)

Intended to aid in maintaining anterior chamber space via irrigation. Flexible tubing 25 cm (10 in). Inner diameter 1 mm (0.04 in); outer diameter 2 mm (0.08 in). Unique annular rings start 0.75 mm from 55 degree bevelled tip for retaining without sutures.



Qty: 3/Bx
Brand: Visitec®

Description	SKU #
20G x 9/64 in, 0.9 x 3.5 mm	585061

ACM Micro Etched (Dahan)

Intended to aid in maintaining anterior chamber space via irrigation. Flexible tubing 15.25 cm (6 in). Inner diameter 0.75 mm (0.03 in), outer diameter 1.6 mm (0.07 in). Special micro etching on tip allows ACM to be self-retaining. Ultra thin wall tip provides high flow rate.



Qty: 10/Bx
Brand: Visitec®

Description	SKU #
20G x 5/32 in, 0.9 x 4 mm, 45 degree beveled tip	585163

Oval ACM (Blumenthal)

Intended to aid in maintaining anterior chamber space via irrigation. 3.5 mm from 40 degree bevelled tip. Flexible tubing 25 cm (10 in). Inner diameter 1 mm (0.04 in), outer diameter 2 mm (0.08 in). Smooth tip allows for straight forward insertion and minimal tissue disturbance.



Qty: 5/Bx
Brand: Visitec®

Description	SKU #
Tapered from 1.25 mm (18G) to 0.9 mm (20G), oval	585149

ISO Hub Gauge Chart

*BVI Gauge Color Chart Located on Page 32.

19G	20G	21G	22G	23G	24G	25G	26G	27G	30G
-----	-----	-----	-----	-----	-----	-----	-----	-----	-----

Hydrodissection Cannulas

Intended to separate the cortex from the capsule via irrigation (hydrodissection).

Nucleus Hydrodissector (Pearce)

Angled 35 degrees, 8 mm from end.



585036

Qty: 10/Bx
Brand: Visitec®

Description	SKU #
● 25G x 7/8 in, 0.5 x 22 mm	585037
● 27G x 7/8 in, 0.4 x 22 mm with 8 mm bend	585036
● 27G x 7/8 in, 0.4 x 22 mm	585274

Nucleus Hydrodelineator (P. Koch)

Intended to break up lens contents and facilitate their aspiration via irrigation.

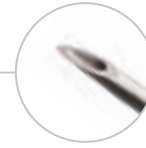

585015

Qty: 10/Bx
Brand: Visitec®

Description	SKU #
● 25G x 7/8 in, 0.5 x 22 mm	585015

Cortical Cleaving Hydrodissector (Flat End)

45 degrees, 11 mm from end. For cleaving cortex from capsular bag.



585158

Qty: 10/Bx
Brand: Visitec®

Description	SKU #
● 27G 7/8 in, 0.4 x 22 mm	585158

Nucleus Hydrodissector (Sinsky)

35 degrees, 8 mm from end.



585195

Qty: 10/Bx
Brand: Visitec®

Description	SKU #
● 25G x 7/8 in, 0.5 x 22 mm	585195

Nucleus Hydrodissector

45 degrees, 7 mm from end.



581592

Qty: 10/Bx
Brand: Visitec®

Description	SKU #
○* 30G x 7/8 in, 0.3 x 22 mm	581592

Nucleus Hydrodissector (Sauter)

Tip is flattened on the vertical plane.



585099

Qty: 10/Bx
Brand: Visitec®

Description	SKU #
● 27G x 7/8 in, 0.4 x 22 mm	585099

Hydrodissection Cannulas

Intended to separate the cortex (tissue) from the capsule via irrigation (hydrodissection).

Nucleus Hydrodissector

Tip is flattened on the horizontal plane.



Qty: 10/Bx
Brand: Visitec®

585155

Description	SKU #
● 27G 7/8 in, 0.4 x 22 mm	585155

Nucleus Hydrodissector (Chang)

90 Degree bend, 1 mm flattened tip.



Qty: 10/Bx
Brand: Visitec®

585294

Description	SKU #
● 27G x 7/10 in, 0.4 x 18 mm, Bevel angle 33 degrees	585294
● 27G x 7/10 in, 0.4 x 18 mm, Bevel angle 47 degrees	585295

Tapered Hydrodelineator (Blumenthal)

Tip is tapered to 0.3 mm (30G), 45 degrees, 4 mm from end.



Qty: 10/Bx
Brand: Visitec®

585107

Description	SKU #
● 25G x 7/8 in, .5 x 22 mm	585107

Cortical Cleaving Hydrodissector (Round End)

45 degrees, 11 mm from end.



Qty: 10/Bx
Brand: Visitec®

585157

Description	SKU #
● 27G x 7/8 in, 0.4 x 22 mm	585157

Nucleus Hydrodissector (Buratto)

Formed, 1 mm bent tip.



Qty: 10/Bx
Brand: Visitec®

585199

Description	SKU #
● 25G x 7/8 in, 0.5 x 22 mm	585199

Cortical Cleaving Hydrodissector (Bolger)

Tip is tapered to 0.3 mm (30G), 33 degrees, 1 mm from end.



Qty: 10/Bx
Brand: Visitec®

585159

Description	SKU #
● 25G x 7/8 in, 0.5 x 22 mm	585159

ISO Hub Gauge Chart

*BVI Gauge Color Chart Located on Page 32.

19G	20G	21G	22G	23G	24G	25G	26G	27G	30G
-----	-----	-----	-----	-----	-----	-----	-----	-----	-----

Hydrodissection Cannulas

Intended to separate the cortex (tissue) from the capsule via irrigation (hydrodissection).

Hydrodissection Cannula (Akahoshi Style)

Tapered tip, Thin wall, Angled 1 mm from end.

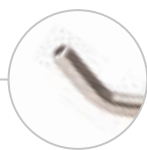
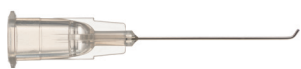

585198

Qty: 10/Bx
Brand: Visitec®

Description	SKU #
● 27G 7/8 in, 0.4 x 22 mm	585198

Micro J Shape Cannula

0.25 mm open end port.
Hook is 1.5 mm long x 1.75 mm wide.

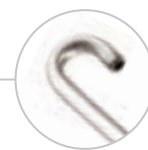

585003

Qty: 10/Bx
Brand: Visitec®

Description	SKU #
● 25G x 7/8 in, 0.5 x 22 mm	585003
● 27G x 7/8 in, 0.4 x 22 mm	585018

Micro J Shape Cannula (Hessburg)

Hook is 0.85 mm long x 1.7 mm wide.

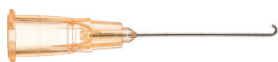

585148

Qty: 10/Bx
Brand: Visitec®

Description	SKU #
● 25G x 3/4 in, 0.5 x 20 mm	585148

Micro J Shape Hydrodissector (Pearce)

Hook is 2.25 mm long x 1.75 mm wide.



585029

Qty: 10/Bx
Brand: Visitec®

Description	SKU #
● 27G x 7/8 in, 0.4 x 22 mm	585029

Cortical Cleaving Hydrodissector (Grabow)

40 degrees, 12 mm from end.



585197

Qty: 10/Bx
Brand: Visitec®

Description	SKU #
○* 30G x 5/8 in, 0.3 x 16 mm	585197

HydroExpression Cannula (Corydon)

1.8 mm from end.



585191

Qty: 10/Bx
Brand: Visitec®

Description	SKU #
● 23G x 7/8 in, 0.6 x 22 mm	585091
● 25G x 7/8 in, 0.5 x 22 mm	585090
● 27G x 7/8 in, 0.4 x 22 mm	585191

Cystotome Cannulas

Intended to perform a capsulorhexis. Indicated for use in cataract surgery.

Irrigating Cystotome



581610

Qty: 10/Bx
Brand: Visitec®

Description	SKU #
● 23G x 5/8 in, 0.6 x 16 mm	581599
● 25G x 5/8 in, 0.5 x 16 mm	581610
● 27G x 5/8 in, 0.4 x 16 mm	581618
○* 30G x 5/8 in, 0.3 x 16 mm	581630

Irrigating Cystotome (Blumenthal)



585043

Qty: 10/Bx
Brand: Visitec®

Description	SKU #
● 27G x 5/8 in, 0.4 x 16 mm	585043

Irrigating Cystotome

Formed 8.5 mm from bend to tip. Shortened curve designed for deep set eyes or small pupils.



585008

Qty: 10/Bx
Brand: Visitec®

Description	SKU #
● 25G 5/8 in, 0.5 x 16 mm	585004
● 27G 5/8 in, 0.4 x 16 mm	585008

Irrigating Formed Cystotome

Tip 45 degrees.



585049

Qty: 10/Bx
Brand: Visitec®

Description	SKU #
● 25G x 5/8 in, 0.5 x 16 mm	585049

Irrigating Cystotome



581594

Qty: 10/Bx
Brand: Visitec®

Description	SKU #
● 23G x 5/8 in, 0.6 x 16 mm	581594
● 25G x 5/8 in, 0.5 x 16 mm	581617

Irrigating Side Cutting Cystotome



581602

Qty: 10/Bx
Brand: Visitec®

Description	SKU #
● 25G x 5/8 in, 0.5 x 16 mm	581602

ISO Hub Gauge Chart

*BVI Gauge Color Chart Located on Page 32.

19G	20G	21G	22G	23G	24G	25G	26G	27G	30G
-----	-----	-----	-----	-----	-----	-----	-----	-----	-----

Cystotome Cannulas

Intended to perform a capsulorhexis. Indicated for use in cataract surgery.

Irrigating Cystotome (Blumenthal)

Formed 8.5 mm from bend to tip.



585113

Qty: 10/Bx
Brand: Visitec®

Description	SKU #
● 25G x 5/8 in, 0.5 x 16 mm	585113
● 27G x 5/8 in, 0.4 x 16 mm	585042

Irrigating Cystotome (Simcoe)

45 Degrees and 10.5 mm from tip.

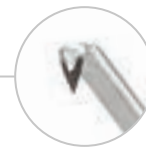

585093

Qty: 10/Bx
Brand: Visitec®

Description	SKU #
● 27G x 1/2 in, 0.4 x 12.5 mm	585093

Blunt Tip Irrigating Cystotome (Kellan)

Tip angled toward bevel. Unique blunt tip creates a wide capsular flap. Useful for pear shape capsulotomies.



585115

Qty: 10/Bx
Brand: Visitec®

Description	SKU #
● 25G x 7/8 in, 0.5 x 22 mm	585115

Irrigating Cystotome (Joyce)

Tip 0.5 mm long.



585030

Qty: 10/Bx
Brand: Visitec®

Description	SKU #
● 25G x 5/8 in, 0.5 x 16 mm	585030
● 27G x 5/8 in, 0.4 x 16 mm	585039

Irrigating Cystotome (Reverse)

Tip 90 degrees toward bevel.



585034

Qty: 10/Bx
Brand: Visitec®

Description	SKU #
● 25G x 5/8 in, 0.5 x 16 mm	585034

Irrigation Cannulas

Intended to be used for irrigation/injection of liquid and/or air.

Bishop Harmon Cannula

Intended for irrigation of the eye.
40 degrees, 8 mm from end.



Qty: 10/Bx
Brand: Visitec®

585040

Description	SKU #
● 19G x 1 in, 1.1 x 25 mm	585040

Anterior Chamber Cannula

30 degrees, 6 mm from end.



Qty: 10/Bx
Brand: Visitec®

581277

Description	SKU #
○ 16G x 1 in, 1.6 x 25 mm	581277

Irrigation and Aspiration Cannulas

Intended to inject ophthalmic viscosurgical devices (OVD).

Viscoflow Formed

Formed 11 mm from end, radius is 19 mm.



Qty: 10/Bx
Brand: Visitec®

585007

Description	SKU #
● 27G x 7/8 in, 0.4 x 22 mm	585007

Viscoflow Cannula

Angled 45 Degrees, 9 mm from end.



Qty: 10/Bx
Brand: Visitec®

585009

Description	SKU #
● 23G x 7/8 in, 0.6 x 22 mm	585009
● 25G x 7/8 in, 0.5 x 22 mm	585045
● 27G x 7/8 in, 0.4 x 22 mm	585026
○* 30G x 7/8 in, 0.3 x 22 mm	585046

ISO Hub Gauge Chart

*BVI Gauge Color Chart Located on Page 32.

19G	20G	21G	22G	23G	24G	25G	26G	27G	30G
-----	-----	-----	-----	-----	-----	-----	-----	-----	-----

Irrigation and Aspiration Cannulas

Intended to aspirate the cortex.

Cortex Extractor

0.3 mm top port.



585075

Qty: 10/Bx
Brand: Visitec®

Description	SKU #
● 23G 5/8 in, 0.6 x 16 mm	585075

Cortex Extractor

0.4 mm top port, thin wall cannula, 30 degrees, 2 mm from end; micro-etched 2 mm from end.



585227

Qty: 10/Bx
Brand: Visitec®

Description	SKU #
● 23G x 15/16 in, 0.6 x 23.5 mm	585227

Cortex Extractor

0.3 mm end port angled 10 degrees. Flat end opening has rounded edges.



585106

Qty: 10/Bx
Brand: Visitec®

Description	SKU #
● 24G x 1/2 in, 0.55 x 12.5 mm	585106

Bimanual Aspiration Cannula

Thin wall cannula, curved 45 degrees, 0.51 mm open end irrigation port.

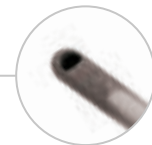

585222

Qty: 10/Bx
Brand: Visitec®

Description	SKU #
● 23G x 5/8 in, 0.6 x 17 mm	585222

Cortex Extractor

0.4 mm top port.



585193

Qty: 10/Bx
Brand: Visitec®

Description	SKU #
● 23G x 5/8 in, 0.6 x 16 mm	585193

Bimanual Aspiration Cannula

Thin wall cannula, curved 45 degrees, 0.51 mm open end irrigation port.



585223

Qty: 10/Bx
Brand: Visitec®

Description	SKU #
● 21G x 5/8 in, 0.8 x 17 mm	585223

Irrigation and Aspiration Cannulas

Intended for irrigation of the eye and/or aspiration of liquids and body fluids.

I and A Cannula Thinwall (Simcoe)

Tubing: Inner diameter 1 mm (0.04 in),
outer diameter 2 mm (0.08 in),
0.3 mm aspiration port.



585047

Qty: 5/Bx
Brand: Visitec®

Description	SKU #
● 23G, 0.6 mm	585047

I and A Cannula (Simcoe)

Tubing: Inner diameter 1 mm (0.04 in),
outer diameter 2 mm (0.08 in),
0.4 mm aspiration port.



585110

Qty: 3/Bx
Brand: Visitec®

Description	SKU #
● 23G, 0.6 mm	585110

I and A Cannula (Simcoe)

Tubing: Inner diameter 1 mm (0.04 in),
outer diameter 2 mm (0.08 in),
0.3 mm aspiration port.



585086

Qty: 3/Bx
Brand: Visitec®

Description	SKU #
● 23G, 0.6 mm	585086

Polishers

Intended to polish the anterior capsule.

Flexible Tip Cannula

Angled 45 Degrees, 7 mm from end,
10 mm sleeve.



585041

Qty: 10/Bx
Brand: Visitec®

Description	SKU #
● 23G x 7/8 in, 0.6 x 22 mm	585041
● 25G x 7/8 in, 0.5 x 22 mm	585017
● 27G x 7/8 in, 0.4 x 22 mm	585005

Capsule Polisher

0.5 mm open end port, 30 degrees, 3 mm
from end and micro-etched 5 mm from end.



581614

Qty: 10/Bx
Brand: Visitec®

Description	SKU #
● 21G x 7/8 in, 0.8 x 22 mm	581614

ISO Hub Gauge Chart

*BVI Gauge Color Chart Located on Page 32.

19G	20G	21G	22G	23G	24G	25G	26G	27G	30G
-----	-----	-----	-----	-----	-----	-----	-----	-----	-----

Polishers

Intended to polish the anterior capsule.

Capsule Polisher (Kratz)

0.3 mm Top port, 35 degrees, 9 mm from end.



581604

Qty: 10/Bx
Brand: Visitec®

Description	SKU #
● 21G x 7/8 in, 0.8 x 22 mm	581604
● 23G x 7/8 in, 0.6 x 22 mm	581605



Olive Tip Cannula

0.33 mm end port. Olive shape tip is 2 mm long x 1 mm wide.



585147

Qty: 10/Bx
Brand: Visitec®

Description	SKU #
● 23G x 7/8 in, 0.6 x 22 mm	585147



Posterior Scraper (Simcoe)

Intended to polish the anterior capsule. 0.33 mm open end port, 60 degrees, 7 mm from end.



581645

Qty: 10/Bx
Brand: Visitec®

Description	SKU #
● 23G x 7/8 in, 0.6 x 22 mm	581645



Olive Tip Polisher

0.33 mm end port, 30 degrees, 10 mm from end and micro-etched 2 mm from end. Olive shape tip is 2 mm long x 1 mm wide.



585143

Qty: 10/Bx
Brand: Visitec®

Description	SKU #
● 23G x 1 in, 0.6 x 25 mm	585143



Glaucoma Revision Picks

Intended for bleb needling.

Glaucoma Revision Pick 60 Degree (Lederer)

60 Degrees, 7 mm from end. Ideal for superior approach.



585133

Qty: 5/Bx
Brand: Visitec®

Description	SKU #
● 27G x 5/8 in, 0.4 x 16 mm	585133



Glaucoma Revision Pick 30 Degree (Lederer)

30 Degrees, 13.5 mm from end. Ideal for temporal or nasal approach.



585135

Qty: 5/Bx
Brand: Visitec®

Description	SKU #
● 27G x 5/8 in, 0.4 x 16 mm	585135



Lacrimal Cannulas

Lacrimal Cannula

Intended to irrigate and probe the lacrimal system. Curved.



581615

Qty: 10/Bx
Brand: Visitec®

Description	SKU #
● 21G x 1-3/8 in, 0.8 x 35 mm	581615
● 26G x 1-1/8 in, 0.45 x 28 mm	581276

Lacrimal Cannula (Shahinian)

Intended to irrigate and probe the lacrimal system. 0.3 mm aspiration port.



585033

Qty: 5/Bx
Brand: Visitec®

Description	SKU #
● 23G x 1/2 in, 0.6 x 12 mm	585033

Lacrimal Cannula

Intended to irrigate and probe the lacrimal system. For irrigating punctum or lacrimal duct.



585016

Qty: 5/Bx
Brand: Visitec®

Description	SKU #
19G x 3/4 in (1.1 x 20 mm) shaft attached to 23G x 1/2 in (0.6 x 12 mm) malleable cannula	585016

Lacrimal Cannula

Straight, 13 mm Length.



585068

Qty: 10/Bx
Brand: Visitec®

Description	SKU #
● 25G x 1/2 in, 0.5 x 13 mm	585068

Lacrimal Trephine (Sisler)

Intended for rotary trepanation of an obstructed canaliculus and/or biopsy of the conjunctiva or sclera.



585031

Qty: 3/Bx
Brand: Visitec®

Description	SKU #
● 21G x 1-1/2 in, 0.8 x 38 mm	585031

ISO Hub Gauge Chart

*BVI Gauge Color Chart Located on Page 32.

19G	20G	21G	22G	23G	24G	25G	26G	27G	30G
-----	-----	-----	-----	-----	-----	-----	-----	-----	-----

Refractive and FLACS

LASIK Irrigating Cannula (Lindstrom)

Intended to irrigate and/or manipulate corneal tissue. Features three 0.25 mm ports located on 7 mm extension with an 11 mm radius, 45 degrees.



585250

Qty: 10/Bx
Brand: Visitec®

Description	SKU #
● 25G x 7/8 in, 0.5 x 22 mm	585250

LASIK Flap Spatula/Irrigator (Hersh)

Intended to irrigate and/or manipulate corneal tissue. 45 Degrees, 9 mm from spatulated tip.



585252

Qty: 10/Bx
Brand: Visitec®

Description	SKU #
● 23G x 7/8 in, 0.6 x 22 mm	585252

LASIK Irrigating Cannula (Solomon)

Intended to irrigate and/or manipulate corneal tissue. Thin wall cannula, angled tip features three 0.25 mm ports on 8 mm extension.



585280

Qty: 10/Bx
Brand: Visitec®

Description	SKU #
● 25G x 7/8 in, 0.5 x 22 mm	585280

LASIK Cannula (Daya)

Intended to irrigate and/or manipulate corneal tissue. 45 degrees, 10 mm from end. Flattened 0.3 mm, 1 mm from tip.



585271

Qty: 10/Bx
Brand: Visitec®

Description	SKU #
● 23G x 7/8 in, 0.6 x 22 mm	585271

FLACS Cannula (Schweitzer)

Intended to open clear corneal incisions created by the Femtosecond laser, Injection of OVD (ophthalmic viscosurgical device) viscoelastic solution into the anterior chamber and to check that capsulorhexis is released for the capsule.



585200

Qty: 10/Bx
Brand: Visitec®

Description	SKU #
● 25G x 7/8 in, 0.5 x 22 mm	585200

LASIK Cannula

Intended to irrigate and/or manipulate corneal tissue. 25 Degrees, formed 7 mm from end.

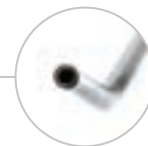

585278

Qty: 10/Bx
Brand: Visitec®

Description	SKU #
● 27G x 7/8 in, 0.4 x 22 mm	585278

Other

Visitec® Double Male Luer Adapter

Standard male luer fittings on each end for connecting phacoemulsification and I/A machine tubing to instruments.



Qty: 50/Bx
Brand: Visitec®

DESCRIPTION	SKU #
3.78 cm (1.5 in) long	581056

Hubs

BVI product hubs comply with ISO 6009 Color coding and ISO 594 Conical fittings with a 6% luer taper to assure use with syringes or devices.

COLOR	HUB	GAUGE	ID (IN)	ID (MM)	OD (IN)	OD (MM)
Natural* (Clear)		30G	0.006	0.15	0.012	0.3
Grey		27G	0.008	0.2	0.016	0.4
Brown		26G	0.01	0.25	0.018	0.45
Orange		25G	0.01	0.25	0.02	0.5
Purple		24G	0.012	0.3	0.022	0.55
Blue		23G	0.013	0.33	0.025	0.6
Black		22G	0.016	0.41	0.028	0.7
Green		21G	0.02	0.51	0.032	0.8
Yellow		20G	0.024	0.6	0.036	0.9
Cream		19G	0.028	0.7	0.043	1.1

*Not an ISO color code.

ISO Hub Gauge Chart

19G	20G	21G	22G	23G	24G	25G	26G	27G	30G
-----	-----	-----	-----	-----	-----	-----	-----	-----	-----

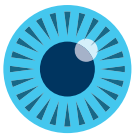

BVI

High Quality Single-Use Instruments

Providing Sterile Options for Your Operating Room Procedures

- **Single-use instruments offer protection against infection, due to decreased risk of cross-contamination¹**
- **Surgeons benefit from precision and reliability of brand-new instruments for each patient²**

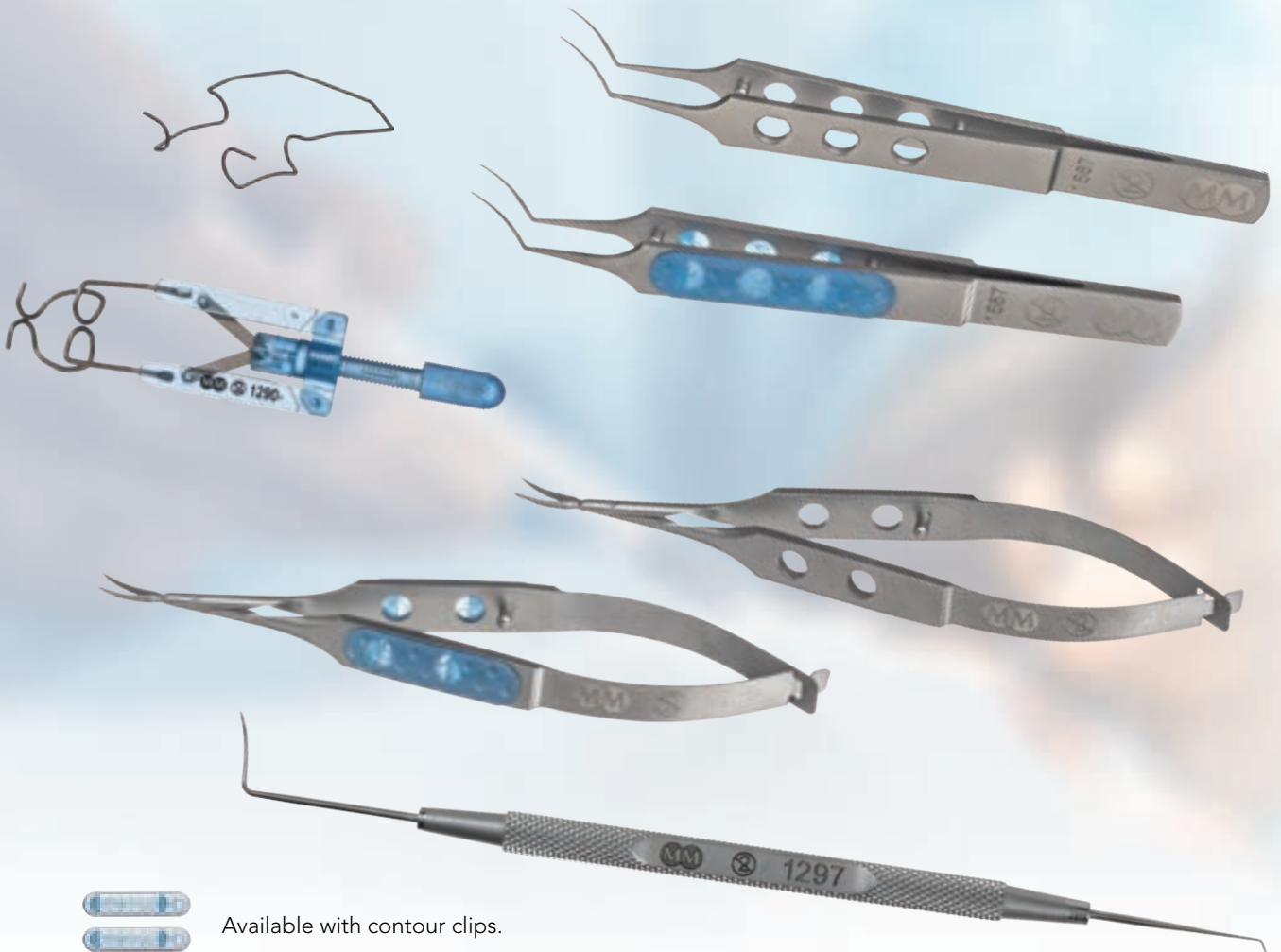

Available with contour clips.

References

¹ Southworth, P.M. Infections and exposures: reported incidents associated with unsuccessful decontamination of reusable surgical instruments. *The Journal of Hospital Infection*. September 17, 2014
² Scheib, Christian; Single-use instruments deserve consideration for eye surgery: Advantages include cost savings, ease of use and high-quality instruments; December 1, 2016

Adjustable Speculums

Plastic Locking Eye Speculum



Qty: 10/Bx
Brand: Visitec®

Description	SKU #
Solid blade, Gear controlled spread, Overall length 83 mm	585297

Mechanical Speculum, Open Blade (PC)



Qty: 20/Bx
Brand: Malosa®

Description	SKU #
5 mm x 14 mm Open blades, 1 mm Wire, Polycarbonate body and screw mechanical speculum	MMSU1290S

Mechanical Speculum Solid Blade



Qty: 20/Bx
Brand: Malosa®

Description	SKU #
6 mm x 14.5 mm Solid curved polycarbonate blades, 0.7 mm Thick, 1 mm Wire, Polycarbonate body and screw mechanical speculum	MMSU1488S

Sprung Speculums

Eye Speculum



Qty: 10/Bx
Brand: Visitec®

Description	SKU #
Open wire loops, 40 x 30 mm, 14 mm blades, 0.8 mm wire size	581413

Kratz-Barraquer Speculum, Temporal



Qty: 20/Bx
Brand: Malosa®

Description	SKU #
6.5 mm x 14 mm Open blades, 0.9 mm Wire, 30 mm Wide	MMSU1253S

Sprung Speculums

Eye Speculum Open Wire Loops



Qty: 10/Bx
Brand: Visitec®

Description	SKU #
Open wire loops. 40 x 30 mm, 14 mm blades, 0.9 mm wire size	581443

Barraquer Speculum, Flat Blade



Qty: 20/Bx
Brand: Malosa®

Description	SKU #
6.5 mm x 14.5 mm Straight closed blades, 1 mm Wire, 30 mm Wide	MMSU1275S

Eye Speculum (Kratz/Barraquer)



Qty: 3/Bx
Brand: Visitec®

Description	SKU #
Open wire loops, 40 x 26.5 mm, Retraction size 13 x 4.5 mm	585094

Kratz-Barraquer Speculum, Curved



Qty: 20/Bx
Brand: Malosa®

Description	SKU #
6.5 mm x 14.5 mm Open curved blades, 0.9 mm Wire, 30 mm Wide	MMSU1287S

Kratz-Barraquer Speculum



Qty: 20/Bx
Brand: Malosa®

Description	SKU #
6.5 mm x 14 mm Open blades, 0.9 mm Wire, 30 mm Wide	MMSU1252S

Barraquer Speculum, Solid Curved (PC)



Qty: 20/Bx
Brand: Malosa®

Description	SKU #
6 mm x 14.5 mm Solid curved polycarbonate blades, 0.7 mm Thick, 0.9 mm Wire, 30 mm	MMSU1474S

Barraquer Speculum, Solid Blade (PC)



Qty: 20/Bx
Brand: Malosa®

Description	SKU #
7 mm x 14.5 mm Solid straight polycarbonate blades, 0.8 mm Thick, 0.9 mm Wire, 30 mm Wide	MMSU1475S

Barraquer Speculum, Solid 18 mm Blade (PC)



Qty: 20/Bx
Brand: Malosa®

Description	SKU #
6 mm x 14.5 mm Solid curved polycarbonate blades, 0.8 mm Thick, 1 mm Wire	MMSU1479S

Pediatric Speculums

Pediatric Eye Speculum



Qty: 3/Bx
Brand: Visitec®

Description	SKU #
Overall size: 34 x 21 mm, Retraction size: 10 x 3.5 mm	585203

Paediatric Speculum, 3cm



Qty: 20/Bx
Brand: Malosa®

Description	SKU #
5.5 mm x 13.5 mm Closed blades, 0.9 mm Wire, 31.5 mm Wide	MMSU1278S

Neonatal Speculum Small



Qty: 20/Bx
Brand: Malosa®

Description	SKU #
3 mm x 7 mm Closed blades, 0.8 mm Wire, 25 mm Wide	MMSU1262S

Fixation Forceps - Toothed

Fine Toothed Forceps Short (Bonn)



SKU# MMSU1123CS

Qty: 20/Bx
Brand: Malosa®

Description	SKU #
0.3 mm 1 x 2 Teeth, 5 mm Tying platforms, 52 mm Handle	MMSU1123S



Adson Forceps, Toothed



Qty: 20/Bx
Brand: Malosa®

Description	SKU #
1.35 mm x 1.8 mm 1 x 2 Teeth, 122 mm Long	MMSU0238S



Toothed Forceps (Bonn)



SKU# MMSU1124CS

Qty: 20/Bx
Brand: Malosa®

Description	SKU #
0.45 mm 1 x 2 Teeth, 5 mm Tying platforms, 80 mm Handle	MMSU1124S



Colibri Toothed Forceps, Short



SKU# MMSU1129CS

Qty: 20/Bx
Brand: Malosa®

Description	SKU #
0.4 mm 1 x 2 Teeth, 5 mm Tying platforms, 52 mm Handle	MMSU1129S



Fixation Forceps - Notched

Fine Notched Forceps, Short (Hoskins)



SKU# MMSU1114CS

Qty: 20/Bx
Brand: Malosa®

Description	SKU #
0.2 mm Notched tips, 5 mm Tying platforms, 52 mm Handle	MMSU1114S

Colibri Notched Forceps, Short



SKU# MMSU1209CS

Qty: 20/Bx
Brand: Malosa®

Description	SKU #
0.2 mm Notched tips, 5 mm Tying platforms, 52 mm Handle	MMSU1209S

Notched Forceps (Hoskins)



SKU# MMSU1115CS

Qty: 20/Bx
Brand: Malosa®

Description	SKU #
0.3 mm Notched tips, 5 mm Tying platforms, 80 mm Handle	MMSU1115S

IOL Removal Forceps

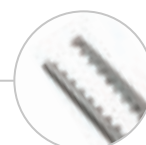

SKU# MMSU1460CS

Qty: 20/Bx
Brand: Malosa®

Description	SKU #
0.1 mm x 0.1 mm Ridges along 4 mm of 15 mm shaft, Angled at 30 degrees, 52 mm Handle	MMSU1460S



Capsulorhexis Forceps

MICS Capsulorhexis Forceps - Curved/Sharp



SKU# MMSU1567CS

Qty: 20/Bx
Brand: Malosa®

Description	SKU #
0.4 mm x 0.3 mm Sharp tips, 12 mm Curved direct action jaws, 1.2 mm at Base of shaft, 80 mm Flat handle	MMSU1567S

Capsulorhexis Forceps Grasping/Curved Tips - Gen 3

Grasping curved tips, round handle.



Qty: 10/Bx
Brand: Visitec®

Description	SKU #
Capsulorhexis Grasping/Curved Tips - Gen 3	581486

MICS Capsulorhexis Forceps - Curved/Grasping



SKU# MMSU1573CS

Qty: 20/Bx
Brand: Malosa®

Description	SKU #
0.4 mm x 0.3 mm Blunt tips, 12 mm Curved direct action jaws, 1.2 mm at Base of shaft, 80 mm Flat handle	MMSU1573S

Capsulorhexis Forceps Sharp/Curved Tips - Gen 3

Sharp curved tips, round handle.



Qty: 10/Bx
Brand: Visitec®

Description	SKU #
Capsulorhexis Forceps Sharp/Curved Tips - Gen 3	581488

MICS Capsulorhexis Forceps - Straight/Sharp



SKU# MMSU1568CS

Qty: 20/Bx
Brand: Malosa®

Description	SKU #
0.4 mm x 0.3 mm Sharp tips, 12 mm Straight direct action jaws, 1.2 mm at Base of shaft, 80 mm Flat handle	MMSU1568S

General Forceps

Adson Forceps, Non-Toothed



Qty: 20/Bx
Brand: Malosa®

Description	SKU #
0.85 mm x 1 mm Tips, 14.5 mm Serrated jaws, 122 mm Long	MMSU0241S

Epilation Forceps



Qty: 20/Bx
Brand: Malosa®

Description	SKU #
5 mm x 7 mm Flat plane tips, 70 mm Handle	MMSU0085S

Jewellers Forceps, Fine Angled



SKU# MMSU0283CS

Qty: 20/Bx
Brand: Malosa®

Description	SKU #
7 mm 45 degree angled pointed tips, 80 mm handle	MMSU0283S

Jewellers Forceps, Fine Straight



SKU# MMSU0286CS

Qty: 20/Bx
Brand: Malosa®

Description	SKU #
7 mm Pointed tips, 80 mm Handle	MMSU0286S

Moorfields Forceps



Qty: 20/Bx
Brand: Malosa®

Description	SKU #
0.6 mm tips, 11.5 mm Serrated jaws, 105 mm Long	MMSU0277S

Jewellers Forceps



Qty: 10/Bx
Brand: Visitec®

Description	SKU #
No. 5, Straight forceps, flat handle, Overall length 100 mm	581458

St Martins Forceps



SKU# MMSU0279CS

Qty: 20/Bx
Brand: Malosa®

Description	SKU #
0.9 mm x 0.26 mm 1 x 2 Teeth, 52 mm Handle	MMSU0279S

Contact Lens Forceps



Qty: 20/Bx
Brand: Malosa®

Description	SKU #
0.6 mm x 0.4 mm Tips, 9 mm Curved Platforms, 70 mm Handle	MMSU1284S

IOL Forceps

Lens Loading Forceps



SKU# MMSU1146CS

Qty: 20/Bx
Brand: Malosa®

Description	SKU #
0.6 mm x 8 mm Tips, 45 Degree angled shaft, 80 mm Handle	MMSU1146S

Tying Forceps

Straight Tying Forceps

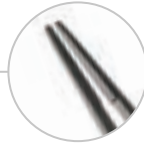

SKU# MMSU1125CS

Qty: 20/Bx
Brand: Malosa®

Description	SKU #
0.35 mm Tip, 5 mm Tying platforms, 80 mm Handle	MMSU1125S

Angled Tying Forceps (McPherson)



SKU# MMSU1127CS

Qty: 20/Bx
Brand: Malosa®

Description	SKU #
0.35 mm Tip, 5 mm Tying platforms, 8 mm Shaft angled 45 degree, 80 mm Handle	MMSU1127S

Curved Tying Forceps



SKU# MMSU1210CS

Qty: 20/Bx
Brand: Malosa®

Description	SKU #
0.25 mm Tips, 5 mm Curved tying platforms, 80 mm Handle	MMSU1210S

Waqar Suture Removal Forceps



SKU# MMSU1583CS

Qty: 20/Bx
Brand: Malosa®

Description	SKU #
0.3 mm x 0.65 mm Pick angled 90 degree, 5 mm Tying platforms, Curved 28 mm shaft, 80 mm Handle	MMSU1583S

Choppers

Claw Chopper

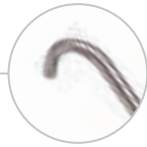

Qty: 20/Bx
Brand: Malosa®

Description	SKU #
Claw Chopper	MMSU1105S

Greens Chopper, Right Handed

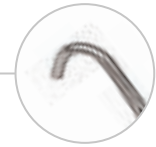

Qty: 20/Bx
Brand: Malosa®

Description	SKU #
Greens Chopper, Right Handed	MMSU1119S

Phaco Chopper



Qty: 20/Bx
Brand: Malosa®

Description	SKU #
Phaco Chopper	MMSU1108S

Nucleus Chopper (P. Koch)

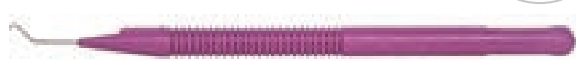

Qty: 3/Bx
Brand: Visitec®

Description	SKU #
45 degrees, 6 mm from tip, tip angled 90 degrees, 1.5 mm from end	585181

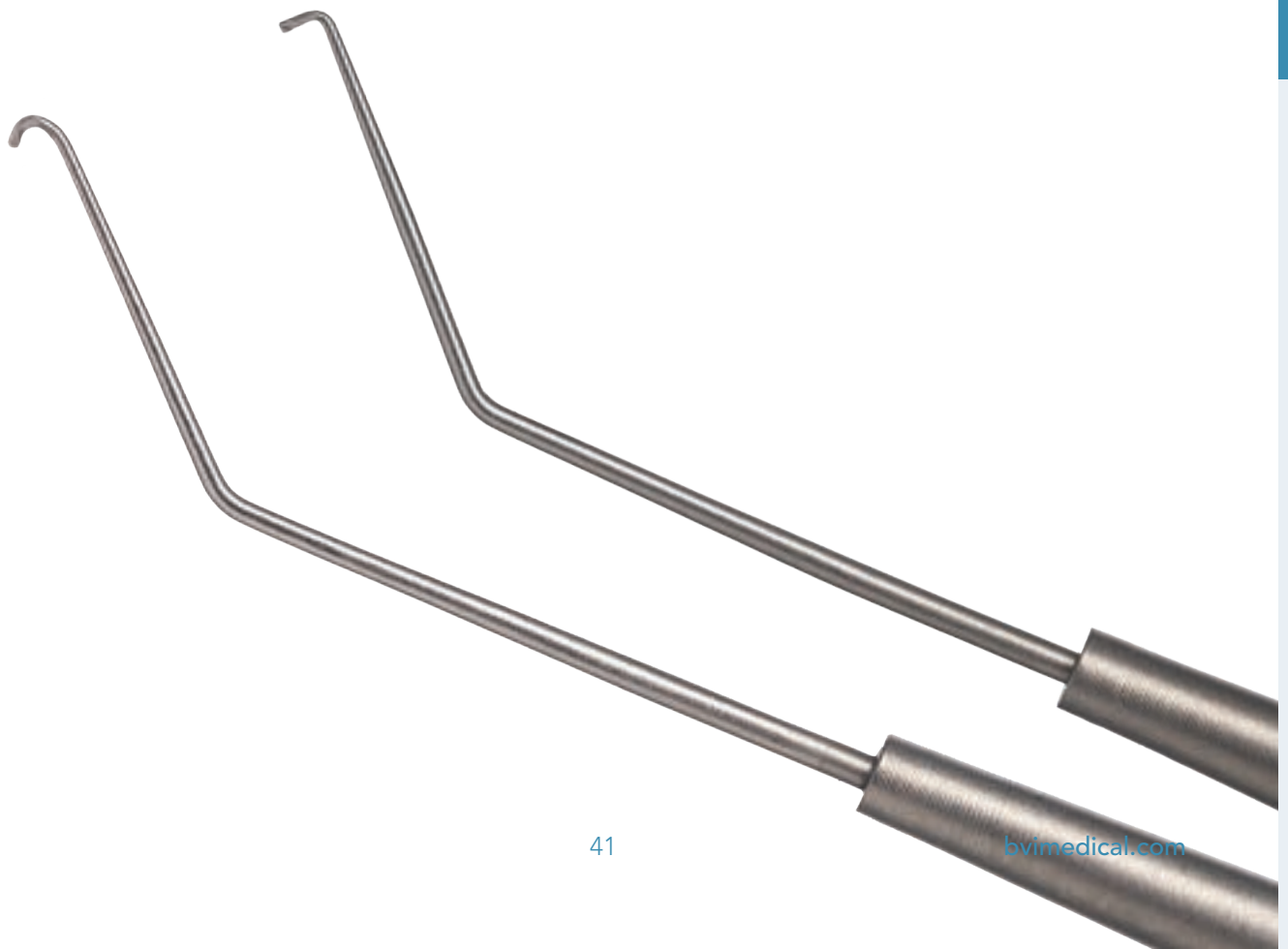

Manipulators

Govan Manipulator



Qty: 20/Bx
Brand: Malosa®

Description	SKU #
Govan Manipulator	MMSU1102S

Mushroom Manipulator



Qty: 20/Bx
Brand: Malosa®

Description	SKU #
Mushroom Manipulator	MMSU1179S

Sinsky Hook



Qty: 20/Bx
Brand: Malosa®

Description	SKU #
Sinsky Hook, 0.2 mm	MMSU1103S

Lester Hook



Qty: 20/Bx
Brand: Malosa®

Description	SKU #
Lester Hook	MMSU1207S

Drysdale Manipulator



Qty: 20/Bx
Brand: Malosa®

Description	SKU #
Drysdale Manipulator	MMSU1144S

Lebuisson Manipulator



Qty: 20/Bx
Brand: Malosa®

Description	SKU #
Lebuisson Manipulator	MMSU1458S

Phaco Chopper/ Mushroom Manipulator



Qty: 20/Bx
Brand: Malosa®

Description	SKU #
Phaco Chopper/Mushroom Manipulator	MMSU1221S

Horizontal Chopper/ Kuglen Hook

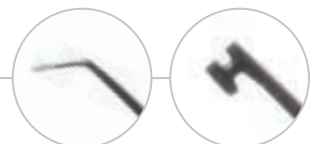

Qty: 20/Bx
Brand: Malosa®

Description	SKU #
Horizontal Chopper/Kuglen Hook	MMSU1231S

Manipulators

ICL Manipulator



Qty: 3/Bx
Brand: Visitec®

Description	SKU #
ICL Manipulator	MMSU1153S

IOL Manipulator Blunt Tip



Qty: 3/Bx
Brand: Visitec®

Description	SKU #
Straight, Blunt tip, Fits 0.2 mm diameter holes and larger	585062

Nucleus Rotator



Qty: 3/Bx
Brand: Visitec®

Description	SKU #
45 degrees, blunt forked tip, 9 mm from end, For rotating nucleus during phacoemulsification	585077

Sinskey Hook - Gen 2



Qty: 10/Bx
Brand: Visitec®

Description	SKU #
Hook Sinskey Disposable - Gen 2	581442

Visitec® Micro-Manipulator, Straight



Qty: 10/Bx
Brand: Visitec®

Description	SKU #
Micro-Manipulator, Straight	581441

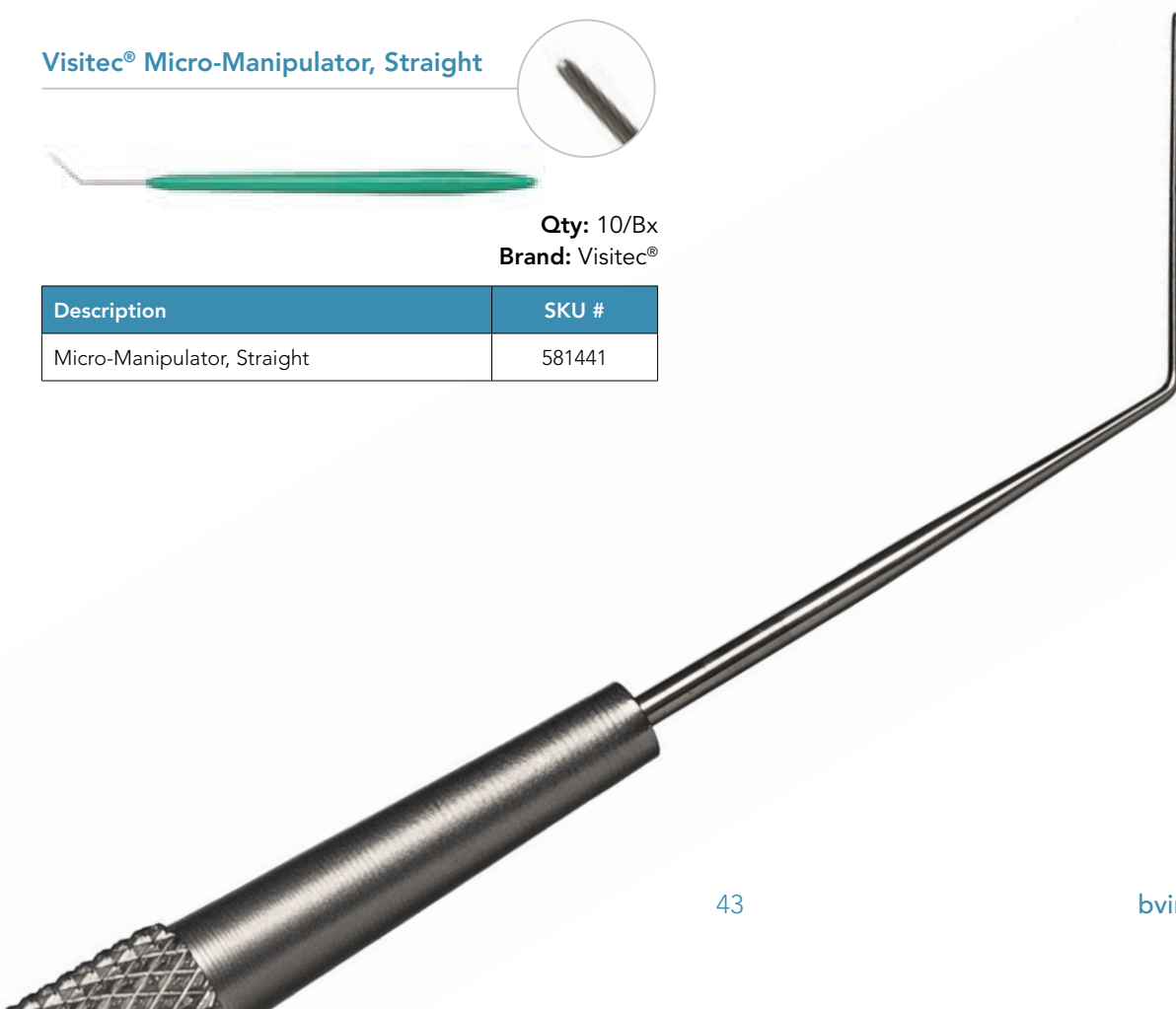

Dissection Scissors

Stevens Tenotomy, Straight, Rounded



Qty: 20/Bx
Brand: Malosa®

Description	SKU #
1.5 mm x 1.5 mm Rounded tips, Straight blades, 110 mm Long	MMSU0214S

Iris Scissors, Straight, Pointed



Qty: 20/Bx
Brand: Malosa®

Description	SKU #
0.1 mm x 0.5 mm Pointed tips, 32.5 mm Straight blades, 120 mm Long	MMSU0249S

Iris Scissors, Curved, Pointed



Qty: 20/Bx
Brand: Malosa®

Description	SKU #
0.1 mm x 0.7 mm Pointed tips, 25 mm Curved blades, 115 mm Long	MMSU0244S

Dressing Scissors

Dressing Scissors, Straight, Pointed



Qty: 20/Bx
Brand: Malosa®

Description	SKU #
0.3 mm Pointed tips, 24.5 mm Straight blades, 102 mm Long, Plastic handle	MMSU0454S

Dressing Scissors, Straight, Rounded



Qty: 20/Bx
Brand: Malosa®

Description	SKU #
0.8 mm Rounded tips, 24.5 mm Straight blades, 102 mm Long, Plastic handle	MMSU0455S

Sprung Scissors

Vannas Scissors, Curved



SKU# MMSU1140CS

Qty: 20/Bx
Brand: Malosa®

Description	SKU #
Pointed tips on 8 mm curved blades, 1.5 mm when closed, 34 mm Handle	MMSU1140S

Westcott Scissors, Curved, Pointed

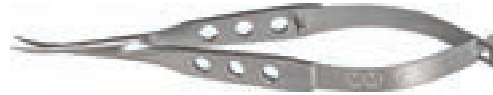

SKU# MMSU1211CS

Qty: 20/Bx
Brand: Malosa®

Description	SKU #
0.5 mm x 0.6 mm Pointed tips, 17.5 mm Curved blades, 36 mm Long	MMSU1211S

Vannas Scissors, Straight



SKU# MMSU1141CS

Qty: 20/Bx
Brand: Malosa®

Description	SKU #
Pointed tips on 8 mm straight blades, 1.5 mm when closed, 34 mm Handle	MMSU1141S

Westcott Scissors, Straight, Pointed

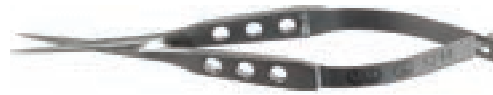

SKU# MMSU1214CS

Qty: 20/Bx
Brand: Malosa®

Description	SKU #
Pointed tips, 17 mm Straight blades, 120 mm Long	MMSU1214S

Westcott Scissors Curved Dolphin Nose



SKU# MMSU1213CS

Qty: 20/Bx
Brand: Malosa®

Description	SKU #
0.5 mm x 0.6 mm Rounded tips, 22 mm Curved 'Dolphin Nose' blades, 120 mm Long	MMSU1213S

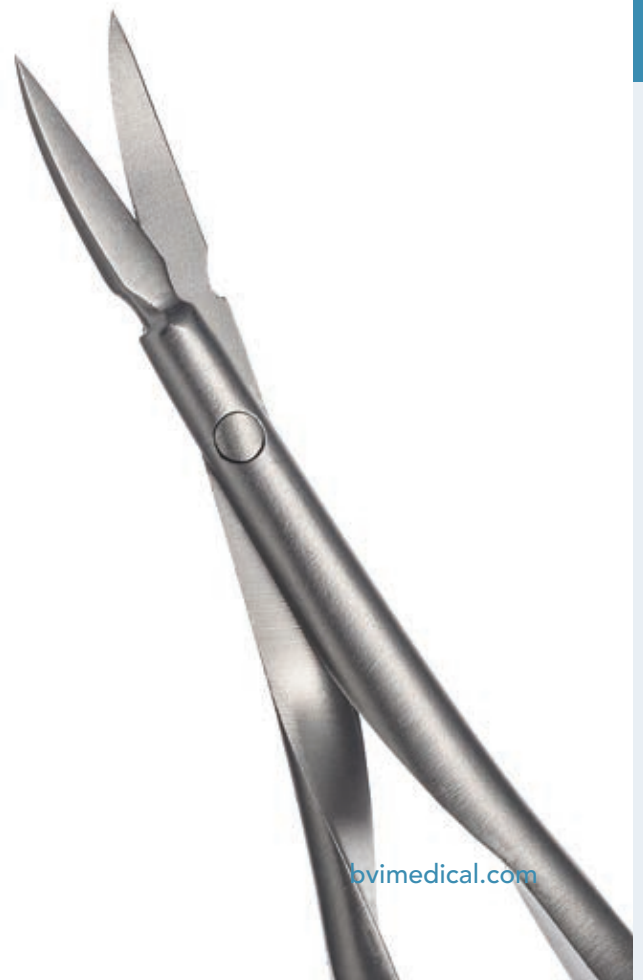

Dressing Forceps

Straight Rampley

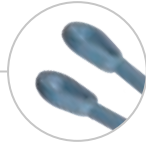
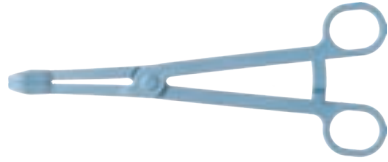

Qty: 10/Bx
Brand: Malosa®

Description	SKU #
11 mm x 23 mm Serrated tips, 180 mm Long, Nylon plastic	MMSU0068S

Rampley Short



Qty: 20/Bx
Brand: Malosa®

Description	SKU #
17 mm x 24 mm Serrated tips, 125 mm Long, Nylon plastic	MMSU1578S

Needle Holders and Drivers

Corneal Needle-Holder



 SKU# MMSU1110CS

Qty: 20/Bx
Brand: Malosa®

Description	SKU #
9 mm Fine curved jaws, 0.45 mm Tip, 106 mm Long	MMSU1110S

Troutman Needle-Holder



 SKU# MMSU1243CS

Qty: 20/Bx
Brand: Malosa®

Description	SKU #
4 mm Fine curved jaws, 0.55 mm Tip, 76 mm Flat handle	MMSU1243S

Barraquer Needle-Holder



Qty: 20/Bx
Brand: Malosa®

Description	SKU #
0.42 mm x 0.45 mm Tips, 4 mm Fine curved jaws with 5 mm shaft, 138 mm Long	MMSU3015S

Flap Elevators and Separators

LASIK Flap Separator/Elevator (Seibel)



Qty: 20/Bx
Brand: Malosa®

Description	SKU #
0.16 mm x 0.28 mm x 1 mm Tip, 20 mm Straight shaft, 0.5 mm x 10.5 mm pointed hook, 52 mm Handle	MMSU1172S

LASIK Flap Separator and Elevator, Binder



Qty: 20/Bx
Brand: Malosa®

Description	SKU #
0.1 mm x 0.3 mm Rounded tip 0.7 mm long, 10 mm Curved 60 degree angled shaft, 75 mm Handle	MMSU1206S

LASIK Flap Elevator Curved 8 mm



Qty: 20/Bx
Brand: Malosa®

Description	SKU #
0.2 mm x 0.15 mm Tip, Curved 8 mm tapered shaft at 90 degrees, 75 mm Handle	MMSU1177S

LASIK Flap Separator/Elevator Curved



Qty: 20/Bx
Brand: Malosa®

Description	SKU #
0.15 mm x 0.3 mm x 8 mm Curved separator at 90 degree to shaft, 0.15 mm x 0.3 mm x 1 mm Pocketing hook, 52 mm Handle	MMSU1294S

Y Shape Corneal Marker



Qty: 20/Bx
Brand: Malosa®

Description	SKU #
2 mm x 8 mm Marking blades, 75 mm Handle	MMSU1134S

Reinstein Lenticule Separator

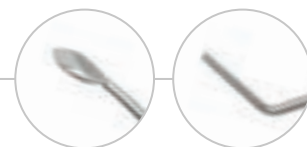

Qty: 20/Bx
Brand: Visitec®

Description	SKU #
0.22 mm x 2 mm Pocketing hook, 1.2 mm x 2 mm Spatula tip, Curved separator at 90 degrees to shaft, 52 mm Handle	MMSU1297S

Flap Elevators and Separators

LASIK Flap Separator/ Elevator Straight

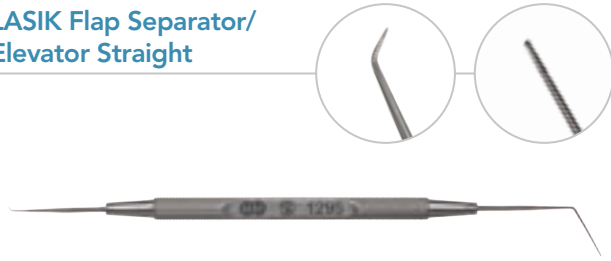

Qty: 20/Bx
Brand: Malosa®

Description	SKU #
0.15 mm x 0.3 mm x 8 mm Straight separator at 90 degree to shaft, 0.15 mm x 0.3 mm x 1 mm Pocketing hook, 52 mm Handle	MMSU1295S

LASIK Flap Roller

Used after realignment. Acts as a squeegee to remove excess fluid from the interface; smooths flap and removes folds.

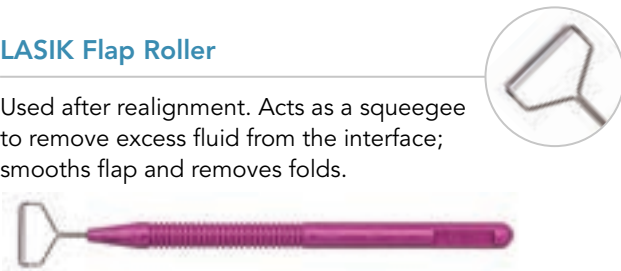

Qty: 5/Bx
Brand: Visitec®

Description	SKU #
14 mm sleeve	585233



Epithelium Spatulas, Hoes and Wells

Corneal Epithelium Spatula Flat



Qty: 20/Bx
Brand: Malosa®

Description	SKU #
5 mm Spatula with 0.9 mm flat blade, 0.8 mm x 1.7 mm Round bladed tip, 75 mm Handle	MMSU1113S

Epithelium Well

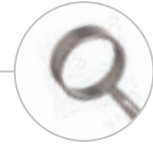

Qty: 20/Bx
Brand: Malosa®

Description	SKU #
3 mm x 8.5 mm ID well, Angled 45 degrees, 75 mm Handle	MMSU1197S
3 mm x 9 mm ID well, Angled 45 degrees, 75 mm Handle	MMSU1196S

Corneal Epithelium Spatula Round



Qty: 20/Bx
Brand: Malosa®

Description	SKU #
2.65 mm x 5.5 mm x 0.35 mm Rounded blade, 75 mm Handle	MMSU1187S

Spatula PRK



Qty: 5/Bx
Brand: Visitec®

Description	SKU #
Spatula tip and top are slightly sharpened to facilitate more aggressive scraping.	585213

Lacrimal Intubation CIS

Guibor Canalculus Intubation Set (CIS)

Includes gently curved, stainless steel probes with smooth, rounded tips. Unique stepped probe design enables smooth transition in pass-through intubation.



Qty: 5/Bx
Brand: Visitec®

Description	SKU #
Probes - 17.7 cm length, 0.64 mm diameter. Biocompatible silicone tubing - 29 cm length, 0.64 mm diameter	8590350

Canaliculus Intubation Set (CIS)

Includes malleable stainless steel stylette encased in low friction nylon sheath. The stylette handles assist in controlled manipulation during insertion and retraction. The rounded tip, nylon sheath offers a smooth transition to silicone tubing.



Qty: 5/Bx
Brand: Visitec®

Description	SKU #
Probes - 15.5 cm length, 0.51 mm diameter. Nylon sheath - 0.81 mm diameter. Biocompatible silicone tubing - 33 cm length, 0.64 mm diameter	8590450

Markers, Gauges and Calipers

Mendez Gauge



Qty: 20/Bx
Brand: Malosa®

Description	SKU #
2.5 mm Polycarbonate ring with 13 mm ID, 0-180 Degree marks in increments of 10, 75 mm Handle	MMSU1152S

Double Ended IVT Guide Pad



Qty: 20/Bx
Brand: Malosa®

Description	SKU #
7 mm Pad with 3.5 guide, 0.8 mm Pad with 4 mm guide, 6 mm 45 Degree angled shafts, 90 mm Long	MMSU1285S

Braunstein IVT Marker 3.5/4



Qty: 20/Bx
Brand: Malosa®

Description	SKU #
2 mm x 1.5 mm Tips with 3.5 mm spread, 2 mm x 1.5 mm Tips with 4 mm spread, 90 mm Long	MMSU1229S

Intravitreal Injection Guide



Qty: 20/Bx
Brand: Malosa®

Description	SKU #
Polycarbonate lash guard with stainless-steel swage guide tube, Triangular base plate with 3 stabilizing studs, 39 mm, 45 Degree angled wishbone handle	MMSU1577S

Braunstein IVT Marker 3.5/4, Green



Qty: 20/Bx
Brand: Malosa®

Description	SKU #
2 mm x 1.5 mm Tips with 3.5 mm spread, 2 mm x 1.5 mm Tips with 4 mm spread, Polycarbonate, 108 mm Long	MMSU1276S

Pointed IVT Marker 3.5/4, Blue



Qty: 10/Bx
Brand: Malosa®

Description	SKU #
2 x 0.55 mm Tips with 3.5 mm spread, 2 x 0.65 mm Tips with 4 mm spread, Polycarbonate, 108 mm Long	MMSU1277S

Corneal Marking Pad



Qty: 10/Bx
Brand: Visitec®

Description	SKU #
Gentian violet. Pre-inked, ready to use. Elongated, flat pad allows easy transfer of ink onto straight markers.	581057

Probes and Dilators

Punctal Dilator and Probe



Qty: 3/Bx
Brand: Visitec®

Description	SKU #
25 mm (1 in) medium taper, Blunt, Wilder style, dilator mated with a size 0 Bowman lacrimal probe, 0.7 mm x 45 mm (22G x 1 3/4 in)	585124

Golf Club Spud



Qty: 20/Bx
Brand: Malosa®

Description	SKU #
0.1 mm x 0.8 mm x 2 mm Oval profile, 18 mm Straight shaft, 75 mm Handle	MMSU1417S

Punctum Dilator, Fine/Medium

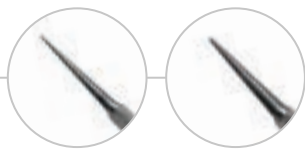

Qty: 20/Bx
Brand: Malosa®

Description	SKU #
0.4 mm x 21.5 mm Tip, 0.6 mm x 18 mm Tip, 77 mm Handle	MMSU1181S

Punctum Dilator/Lacrimal Probe

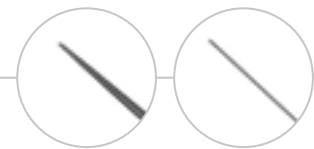

Qty: 20/Bx
Brand: Malosa®

Description	SKU #
0.28 mm x 25 mm Dilator, 0.7 mm x 44.5 mm Probe, 70 mm Handle	MMSU1419S

Punctum Dilator/Seeker

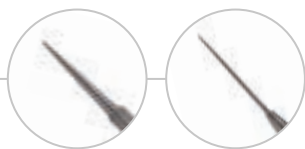

Qty: 20/Bx
Brand: Malosa®

Description	SKU #
0.45 mm x 21.5 mm Tip, 5 mm Pointed tip, 18 mm Straight shaft, 77 mm Handle	MMSU1193S



Clamps and Curettes

Chalazion Clamp, Oval



Qty: 20/Bx
Brand: Malosa®

Description	SKU #
13 mm x 20 mm Oval profile, 10 mm x 17 mm Aperture, 90 mm Long	MMSU1149S

Chalazion Clamp, Round



Qty: 20/Bx
Brand: Malosa®

Description	SKU #
12 mm Round profile, 9 mm Round aperture, 90 mm Long	MMSU1150S

Chalazion Curette, Double, 1 mm/2 mm



Qty: 20/Bx
Brand: Malosa®

Description	SKU #
1 mm Curette, 1 mm Depth, 2 mm Curette, 1.35 mm Depth, 128 mm Long	MMSU1157S

Chalazion Curette, Double, 2 mm/3 mm



Qty: 20/Bx
Brand: Malosa®

Description	SKU #
2 mm Curette, 1.35 mm Depth, 3 mm Curette, 1.6 mm Depth, 128 mm Long	MMSU1158S

Fixation Rings

Thornton Fixation Ring



Qty: 10/Bx
Brand: Visitec®

Description	SKU #
0.5 mm Thick 6.5 mm radius ring, 2 mm x 0.9 mm Teeth at 5 mm intervals, 75 mm Handle	MMSU1137S

Fixation Ring



Qty: 20/Bx
Brand: Malosa®

Description	SKU #
0.5 mm Thick 13 mm internal diameter ring, 1.5 mm x 0.6 mm Teeth at 3.5 mm intervals, 1.3 mm x 0.4 mm Teeth at 0.9 mm intervals, 75 mm Handle	MMSU1495S

Swivel Fixation Ring



Qty: 10/Bx
Brand: Visitec®

Description	SKU #
13 mm Diameter	372242



Small Pupil Expansion

Experience the Latest Innovation in Small Pupil Expansion with the I-Ring[®] Pupil Expander

- Designed to be used without any additional cornea incision
- Created to avoid any iris distortion and damage during surgery and post surgery
- Designed to have 360° expansion on the iris



Pupil Expansion

I-Ring® Pupil Expander

The I-Ring® is designed to expand the iris to increase the surgeon's field of view and helps improve access to the lens while protecting the iris. Single-use sterile product.

- Designed to be gentle on iris and other intraocular tissue
- Created to support iris returning to natural shape post surgery
- Straight-forward insertion and removal

Description	SKU #
I-Ring® Pupil Expander, 6/Pk	587000
I-Ring® Pupil Expander, 1/Pk	587001

Positioning Holes

- Designed to ensure Sinskey hook cannot contact iris

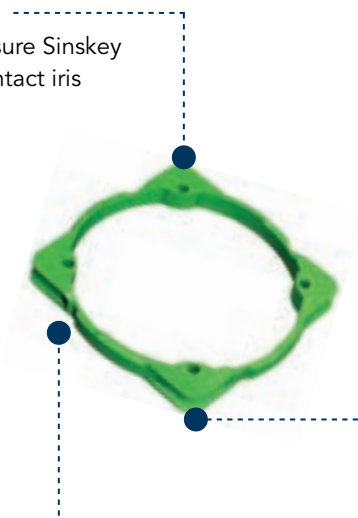

I-Ring® Pupil Expander

Channels

- Designed to not distort or pinch iris when engaged or removed
- Straight-forward engagement and disengagement

Living Hinges

- Created for enhanced flexibility of ring
- Designed for reliable folding during insertion and removal

Sinskey Hook

Used to manipulate nucleus or intraocular lenses.



Qty: 10/Bx
Brand: Visitec®

Description	SKU #
Angled 45 degrees, 10 mm from tip, Hook 0.85 mm tip to bend distance, Overall length 130 mm	581442

Micro Iris Hook

Flexible, gold wire hooks designed to retract the iris during surgical procedures.



Qty: 25/Bx
Brand: Visitec®

Description	SKU #
8 mm long x 0.08 mm diameter	585209

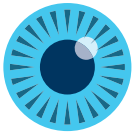

BVI

Fluid Control

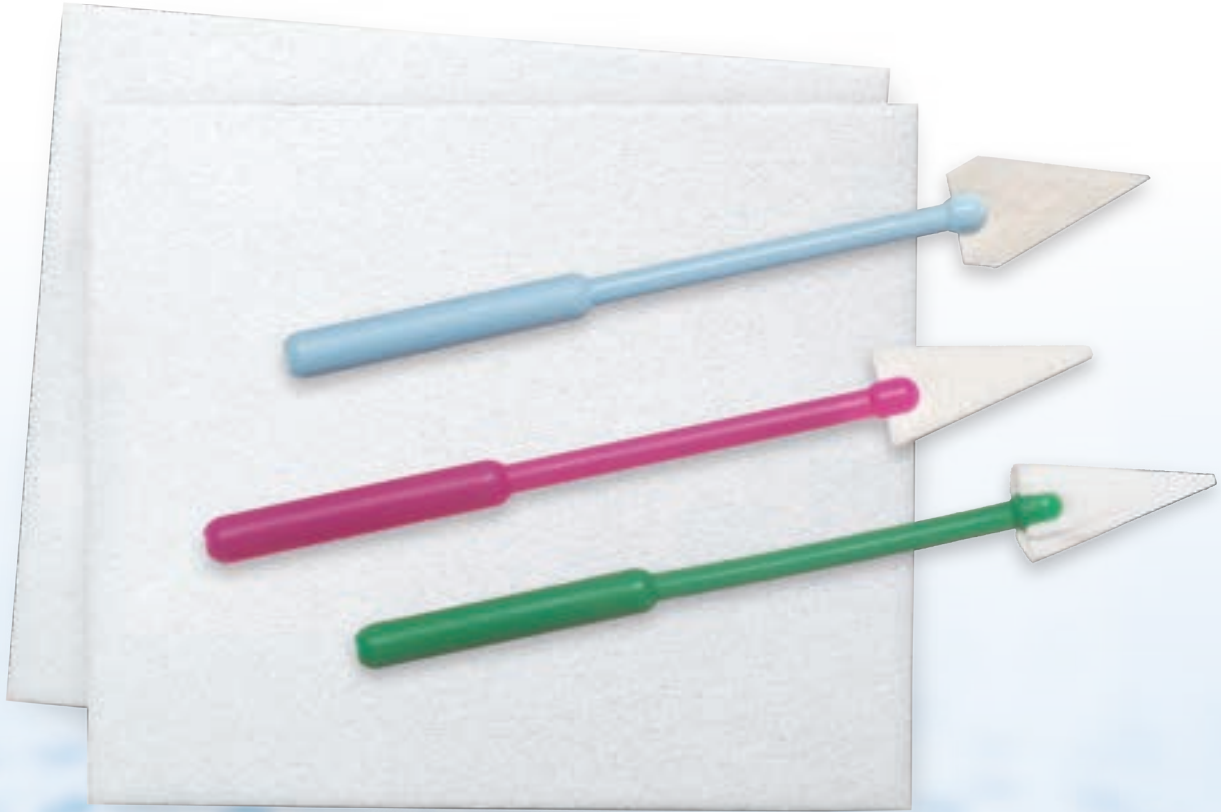

PVA Eye Spears

Spear overall handle length is 7.16 cm or 2.82 in.

UltraClean™ LASIK PVA Eye Spears

Compressed shape, designed for fast expanding. Made from highly absorbent, virtually lint free PVA material. Designed specifically for rapid recovery of fluids during LASIK and other corneal procedures.



Qty: 100/Bx
Brand: UltraClean™

Description	SKU #
UltraClean™ Eye Spears, 5/Pouch, 20/Pouch per box	40810
UltraClean™ Eye Spears, 10/Pouch, 10/Pouch per box	40815

Visitec® LASIK PVA Expanded Eye Spear

Made from highly absorbent PVA material. Pre-expanded for convenience. Designed to provide instantaneous wicking. No need to pre-soak and fan.



Qty: 40/Bx
Brand: Visitec®

Description	SKU #
LASIK Expanded Spear	581709

Visitec® LASIK PVA Eye Spears

Made from highly absorbent PVA material. Designed for optimal tissue manipulation and fluid absorption to facilitate flap alignment and adhesion.



Qty: 100/Bx
Brand: Visitec®

Description	SKU #
LASIK Eye Spear - Orange	581761

Weck-Cel® Cellulose Eye Spears

Made from highly absorbent, natural, cellulose material. Designed for use in delicate, surgical areas and to maintain rigidity during wicking process. Light blue handle.



Qty: Various/Bx
Brand: Weck-Cel®

Description	SKU #
Weck-Cel® Spears, 6 Pack, 144/Bx	0008680
Weck-Cel® Spears, 10 Pack, 180/Bx	0008685

Visitec® Cellulose Eye Spears

Made from highly absorbent, natural, cellulose material. Designed for fast wicking action, delivers quick absorption of fluid from the surgical area. The flat tip provides precise application at the surgical incision. Magenta handle.



Qty: 100/Bx
Brand: Visitec®

Description	SKU #
Sponge Eye, 7 cm (2.75 in) overall length.	581089

Corneal Light Shields

Visitec® Corneal Light Shield

PVA absorbent pad. Soft, porous structure designed to protect the retina from operating microscope light. Contains no cellulose. Upon moistening, shield becomes soft and conforms to shape of cornea. Designed to keep cornea moist.



Qty: 20/Bx
Brand: Visitec®

Description	SKU #
Visitec® Corneal Light Shield, 8 mm (0.3 in) diameter	581062



Full Body Drapes

Full body drapes feature wider widths and a three-sided channel bag for maximum fluid capacity. Full body drapes can be utilized in all ophthalmic procedures.

Full Body Incise Drape

Qty: 10/Bx

Description	SKU #
Non-Woven Incise Drape with 2 Bags	581156
Overall size:	140 cm x 244 cm (55 in x 96 in)
Incise area:	13 cm x 15 cm (5 in x 6 in)
Fluid collection bag:	25 cm x 15 cm (10 in x 6 in)
Capacity:	2 x 500 mL
Material Type:	Non-Woven Wetlaid



Full Body Aperture Drape

Qty: 10/Bx

Description	SKU #
Full Body Aperture Drape with 2 Bags	581157
Overall size:	140 cm x 244 cm (55 in x 96 in)
Aperture area:	4 cm x 6 cm (1.5 in x 2 in)
Capacity:	2 x 500 mL
Material Type:	Non-Woven Wetlaid



Full Body Incise Drape with Plastic Head and Channel Bag

Qty: 10/Bx

Description	SKU #
Full Body Incise Drape with Plastic Head and Channel Bag	581163
Overall size:	160 cm x 252 cm (63 in x 99 in)
Incise Area:	13 cm x 15 cm (5 in x 6 in)
Channel Bag:	62 cm x 40 cm (24 in x 16 in)
Capacity:	1000 ml
Material Type:	SMS 157 cm (61 in), Plastic 100 cm (39 in)

*Without wick



Non-Woven Full Body Incise Drape

Qty: 10/Bx

Description	SKU #
Non-Woven Full Body Incise Drape	581164
Overall size:	160 cm x 252 cm (60 in x 99 in)
Incise area:	13 cm x 15 cm (5 in x 6 in)
Channel bag:	62 cm x 40 cm (24 in x 16 in)
Capacity:	1000 ml
Material Type:	Non-Woven Wetlaid



Half Body Drapes

Plastic Incise Drape with Fluid Collection Bag

Qty: 10/Bx

Description	SKU #
Plastic Incise Drape with Fluid Collection Bag	581149
Overall size:	100 cm x 127 cm (39 in x 50 in)
Incise area:	13 cm x 15 cm (5 in x 6 in)
Fluid collection bag:	18 cm x 16.5 cm (7 in x 6.5 in)
Capacity:	250 ml
Material Type:	Polyethylene Opaque Film



Plastic Aperture Drape with Fluid Collection Bag

Qty: 10/Bx

Description	SKU #
Plastic Aperture Drape with Fluid Collection Bag	581151
Overall size:	100 cm x 127 cm (39 in x 50 in)
Aperture area:	4 cm x 6 cm (1.5 in x 2 in)
Fluid collection bag:	18 cm x 16.5 cm (7 in x 6.5 in)
Capacity:	250 ml
Material Type:	Polyethylene Opaque Film



Non-Woven Incise Drape with Fluid Collection Bag

Qty: 10/Bx

Description	SKU #
Non-Woven Incise Drape with Fluid Collection Bag	581150
Overall size:	100 cm x 127 cm (39 in x 50 in)
Incise area:	13 cm x 15 cm (5 in x 6 in)
Fluid collection bag:	18 cm x 16.5 cm (7 in x 6.5 in)
Capacity:	250 ml
Material Type:	Non-Woven Wetlaid



Half Body Drapes

Non-Woven Aperture Drape with Fluid Collection Bag

Qty: 10/Bx

Description	SKU #
Non-Woven Aperture Drape with Fluid Collection Bag	581152
Overall size:	100 cm x 127 cm (39 in x 50 in)
Aperture area:	4 cm x 6 cm (1.5 in x 2 in)
Fluid collection bag:	18 cm x 16.5 cm (7 in x 6.5 in)
Capacity:	250 ml
Material Type:	Non-Woven Wetlaid



Non-Woven Incise Drape with Channel Bag

Qty: 10/Bx

Description	SKU #
Non-Woven Incise Drape with Channel Bag	581153
Overall size:	140 cm x 127 cm (55 in x 50 in)
Incise area:	13 cm x 15 cm (5 in x 6 in)
Fluid collection bag with channels:	26 cm x 35 cm (10 in x 14 in)
Capacity:	500 ml
Material Type:	Non-Woven Wetlaid

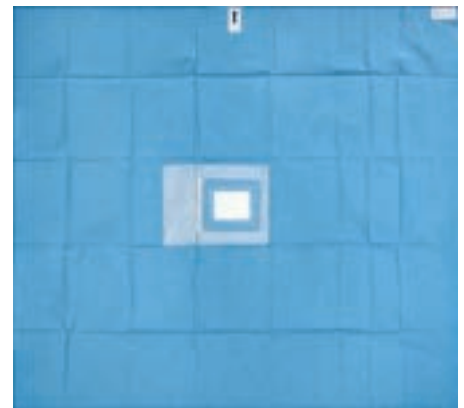

Non-Woven Aperture Drape with Channel Bag

Qty: 10/Bx

Description	SKU #
Non-Woven Aperture Drape with Channel Bag	581155
Overall size:	140 cm x 127 cm (55 in x 50 in)
Aperture area:	4 cm x 6 cm (1.5 in x 2 in)
Fluid collection bag with channels:	26 cm x 35 cm (10 in x 14 in)
Capacity:	500 ml
Material Type:	Non-Woven Wetlaid



Half Body Drapes

Non-Woven Half Body Incise Drape* with Channel Bag

Qty: 10/Bx

Description	SKU #
Non-Woven Half Body Incise Drape* with Channel Bag	581166
Overall size:	160 cm x 180 cm (63 in x 71 in)
Incise area:	13 cm x 15 cm (5 in x 6 in)
Channel bag:	62 cm x 40 cm (24 in x 16 in)
Capacity:	1000 ml
Material Type:	SMS

*Without wick



Face Drapes

Ideal for refractive or office procedures.

Mini Pre-Split Incise Drape

Adhesive backing.

Qty: 10/Bx

Description	SKU #
Mini Pre-Split Incise Drape	581154
Overall size:	40 cm x 40 cm (16 in x 16 in)
Incise area:	13 cm x 15 cm (5 in x 6 in)
Pre-split:	5 cm (2 in)
Material Type:	SMS

*Without wick

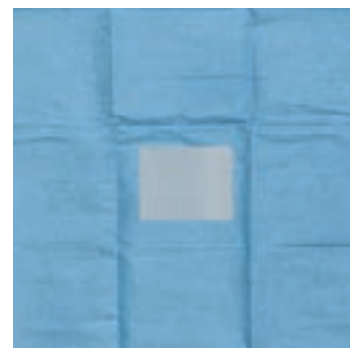

Mini Plastic Incise Drape

Adhesive backing.

Qty: 10/Bx

Description	SKU #
Mini Plastic Incise Drape	581159
Overall size:	40 cm x 40 cm (16 in x 16 in)
Incise area:	13 cm x 15 cm (5 in x 6 in)
Material Type:	Polyethylene Opaque Film

*Without wick



Face Drapes

Mini Plastic Aperture Drape

Adhesive backing.

Qty: 10/Bx

Description	SKU #
Mini Plastic Aperture Drape	581160
Overall size:	40 cm x 40 cm (16 in x 16 in)
Aperture area:	4 cm x 6 cm (1.5 in x 2 in)
Material Type:	Polyethylene Opaque Film

*Without wick



Mini Plastic Aperture Drape

Small incise provides complete coverage of lashes, lids and brows. Converts aperture to incise drape.

Qty: 10/Bx

Description	SKU #
Incise Drape	581161
Overall size:	10 cm x 20 cm (4 in x 8 in)
Adhesive area:	11 cm x 16 cm (4 in x 6 in)
Material Type:	Polyethylene Opaque Film

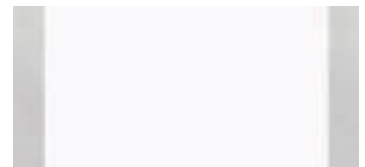

Dual Refractive Drape

Qty: 10/Bx

Description	SKU #
Dual Refractive Drape	581162
Overall size:	40 cm x 26 cm (16 in x 10 in)
Aperture area:	2.5 cm x 4 cm (1 in x 1.5 in)
Material Type:	Polyethylene Opaque Film



Drape Accessories

Visitec® Fluid Collection Bags

For procedures where collection and control of fluid is designed to keep surgeon, patient and floor dry. Reduces operating room cleanup and turnaround time. Bags have an adhesive backing to adhere to surgical drape.

Qty: 20/Bx
Brand: Visitec®



Description	SKU #
Fluid Collection Bag: 17 cm x 16 cm (6.75 in x 6 1/4 in), 250 ml capacity	581177
Fluid Collection Bag with Wick Bag: 17 cm x 16 cm (6.75 in x 6.25 in), 250 ml capacity Wick: Includes one, 0.4 cm x 15 cm (0.15625 in x 5.875 in)	581146
Mini Fluid Collection with Wick Bag: 9 cm x 16 cm (3.5 in x 6.25 in), 100 ml capacity Wick: Includes one, 0.4 cm x 15 cm (0.15625 in x 5.875 in)	581148

Visitec® Eye Fluid Wick

Wicks absorb and direct fluid from surgical area into fluid collection bag.



Qty: 20/Bx
Brand: Visitec®

Description	SKU #
Eye fluid wick, 15 cm Long x 0.4 cm Wide	581147

Eye Drains

Visitec® LASIK Eye Drain (Chayet)

Designed to reduce stromal bed hydration for a consistent ablation and for nasally hinged flaps.



Qty: 20/Bx
Brand: Visitec®

Description	SKU #
LASIK Eye Drain 10 mm	581098

Instrument Wipes

Visitec® Visiwipe Instrument Wipes



Qty: 20/Bx
Brand: Visitec®

Description	SKU #
Instrument Wipe, 7.3 cm x 7.3 cm (2.875 in x 2.875 in)	581047
Adhesive Wipe, 7.6 cm x 4.5 cm (3 in x 1.75 in)	581076

Other Fluid Control

Absorbent Stick

6.6 cm overall length x 5 mm diameter (2.59 in x 0.1875 in)



Qty: 250/Bx
Brand: Visitec®

Description	SKU #
Absorbent Stick 6.3 cm, 10 per pouch, 25 pouches per box.	581060

Visiswab Cotton Swabs

Pointed end may be used as a second instrument to absorb blood and fluid, move sutures and manipulate tissue. Rounded end may be used for scleral depression. Tightly wound ends create less linting than other cotton swabs. 7.6 cm (3 in) overall length. 10 per pouch, 25 pouches per box.



Qty: 250/Bx
Brand: Visitec®

Description	SKU #
Visiswab Cotton 7.6 cm (3 in) length	581069

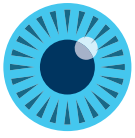

BVI

Quality Accessories to Support You and Your Patients Needs



Eye Shields



Eye Bandage

Eye Shields and Bandages

Eye Shield (Left/Right)

White lightweight plastic eye shield with ventilation holes. Flexible eye shield, shaped to fit the right or left eye for protection. Smooth edges do not require a cover. Packaged sterile.



Qty: 50/Bx
Brand: Visitec®

Description	SKU #
Eye Shield, Left/Right 8.5 cm (3.3 in)	581019

Universal Pediatric Eye Shield

Clear lightweight plastic and features smooth edges and ventilation holes. For use on left or right eye. Packaged sterile.



Qty: 25/Bx
Brand: Visitec®

Description	SKU #
Pediatric Eye Shield	581708

Universal Eye Shield

Clear lightweight plastic, for use on left or right eye, that features smooth edges and ventilation holes. Packaged sterile.



Qty: 50/Bx
Brand: Visitec®

Description	SKU #
Universal Eye Shield, 7.5 cm x 6.5 cm (3 in x 2.5 in)	581040

Visitec® Guibor Eye Bandage

Disposable self-adhesive eye dressing designed to protect the eye during drying conditions, such as "dry eye". Straightforward to apply. Packaged sterile.



Qty: 10/Bx
Brand: Visitec®

Description	SKU #
Eye Bandage, Guibor Bubble Bandage	8590300

Visitec® Bulk High Flow Filter

Filters out particulates and microbiological contamination of 0.2 micron and larger.



Qty: 50/Bx
Brand: Visitec®

Description	SKU #
0.2 micron Filter	581030

Visitec® Double Male Luer Adapter

Standard male luer fittings on each end for connecting phacoemulsification and I/A machine tubing to instruments.



Qty: 50/Bx
Brand: Visitec®

Description	SKU #
3.78 cm (1.5 in) long	581056

Corneal Marking Pad

Elongated, flat pad allows easy transfer of ink onto markers.



Qty: 10/Bx
Brand: Visitec®

Description	SKU #
Gentian violet, Pre-inked, Ready to use	581057

Superflex Extension Set



Qty: 20/Bx
Brand: Visitec®

Description	SKU #
Superflex Extension Set	581007



Experience

the Evolution

REIMAGINE Your Operating Room



Custom Packs

CustomEyes®



Knowledgeable Support

- Experienced ophthalmic sales team
- We understand your operating room
- Information at the fingertips



Reliable Quality

- Top-notch quality
- Access to BVI's wide range of single-use instruments



Personalized Packs

- Individualization to each of your surgeon's needs
- Quickly adapt to staff or technique changes



Simplified Surgical Prep

- 3D visualization of pack layers
- Pack assembly to match your operations



Easy Order Process

- Real-time quote and pricing
- Sample in 2 weeks

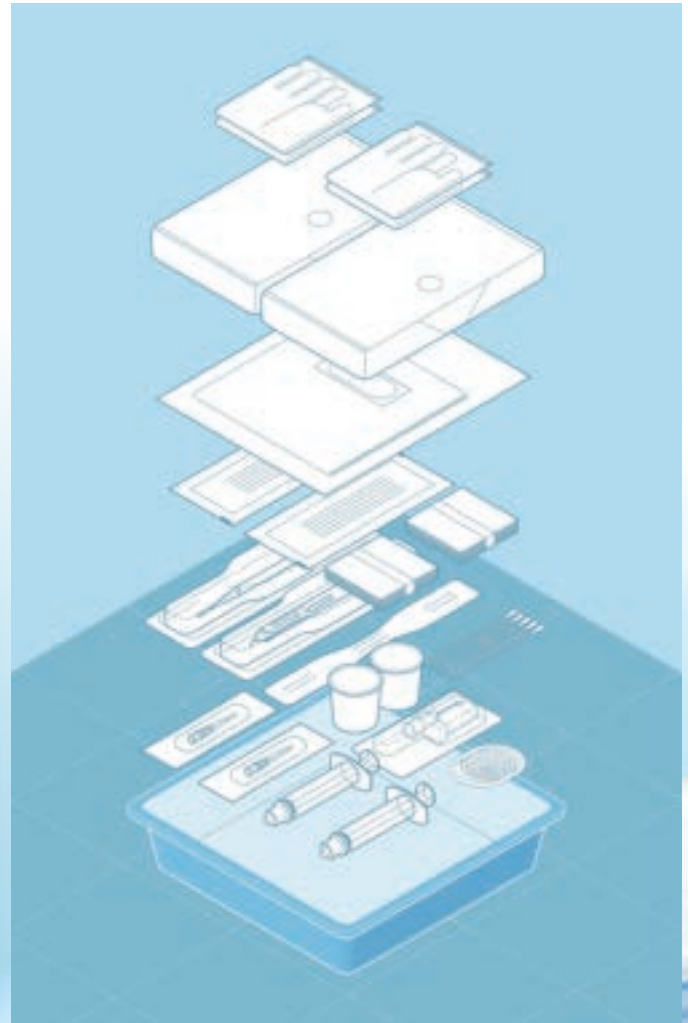

Custom Packs

CustomEyes® Configurator

The CustomEyes Configurator allows our team of ophthalmic specialists to easily create the right pack for you.



Simple Product Selection

Allows you to choose the product characteristics and select the best product combination for your needs.



Visual Pack Assembly

Optimize the layout of the pack by seeing a virtual 3D layering including order and orientation of each component.



Instant Feedback

Start building a pack together with your rep to get instant feedback and customize quickly.



Actualize

Receive a quote, order a sample and initiate production directly from the app.



CustomEyes®

Custom Procedure Packs



Knowledgeable Support



Reliable Quality



Personalized Packs

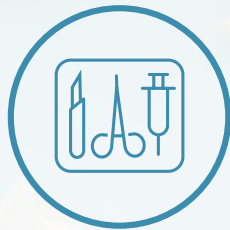

Simplified Surgical Prep



Easy Order Process



Experience the Evolution

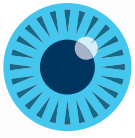

BVI

Electrosurgery and Electrocautery



Cautery Devices

Accu-Temp Cauteries provide a broad selection of tip styles for cauterization in a wide variety of ophthalmic procedures. All products are single-use and provided sterile.

Accu-Temp® High Temperature Cautery

Qty: 10/Bx
Brand: Accu-Temp®



8442000

Description	SKU #
1,150°C (2,102°F), 1/2 in (12.7 mm) Shaft with fine tip	8442000



8443000

Description	SKU #
1,150°C (2,102°F), 1/2 in (12.7 mm) Shaft with loop tip	8443000



8444000

Description	SKU #
1,150°C (2,102°F), 2 in (50.8 mm) Shaft with loop tip	8444000



8445000

Description	SKU #
1,150°C (2,102°F), 2 in (50.8 mm) Shaft with fine tip	8445000

Accu-Temp® Low Temperature Cautery

Qty: 10/Bx
Brand: Accu-Temp®



8441000

Description	SKU #
612°C (1,134°F), 1/2 in (12.7 mm) Shaft with fine tip	8441000

Accu-Temp® Variable Temperature Cautery - Dialed Controlled

Qty: 10/Bx
Brand: Accu-Temp®



Low Temperature

8440000

Description	SKU #
150° - 612°C (302° - 1,134°F), 1/2 in (12.7 mm) Shaft with fine tip	8440000



High Temperature

8446000

Description	SKU #
506° - 1,150°C (943° - 2,102°F), 1/2 in (12.7 mm) Shaft with fine tip	8446000

Erasers

Wet-Field® Erasers intended for coagulation in vitreoretinal procedures, glaucoma filtration and cataract incision. Sterile and single-use.

Wet-Field® Hemostatic Eraser Bipolar Bevel Tip

Qty: 10/Bx
Brand: Wet-Field®



221250

Description	SKU #
18G Bevel tip, Straight	221250

Wet-Field® Hemostatic Eraser Bipolar Blunt Tip



221251



221260135



221260150



221260

Qty: 10/Bx
Brand: Wet-Field®

Description	SKU #
18G Blunt tip, Angled 45 degrees	221251
20G Blunt tip, Angled 135 degrees	221260135
20G Blunt tip, Angled 150 degrees	221260150
20G Blunt tip, Straight	221260



Erasers

Wet-Field® Hemostatic Eraser Bipolar Fine Tip

Qty: 5/Bx
Brand: Wet-Field®



Description	SKU #
23G Fine tip, Straight	221268
23G Fine tip, Angled 150 degrees	221268150
25G Fine tip, Straight	221267
25G Fine tip, Angled 135 degrees	221267135

Wet-Field® Hemostatic Eraser Bipolar 20G - 23G Tapered Tip

Qty: 5/Bx
Brand: Wet-Field®

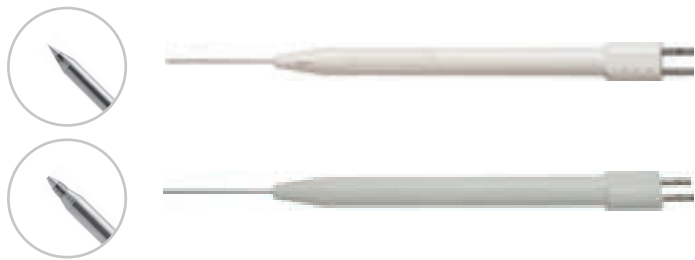

Description	SKU #
20 - 23G Tapered Fine Tip, Straight	221265

Description	SKU #
20 - 23G Tapered Blunt Tip, Straight	221266

Cables

Qty: 10/Bx
Brand: Wet-Field®



22155010

Description	SKU #
Wet-Field® Disposable Cable Shrouded	22155010



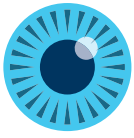

BVI

Providing Relief for Patients with Dry Eye or Lacrimal Disorders

Parasol[®] | Micro Flow[™]



**Permanent
Parasol[®]**



**Partial
Micro Flow[™]**

Permanent Occlusion

Dry eye products that offer predictable retention¹, straight-forward sizing and insertion. All occluder products are made of medical grade silicone and are reversible.

Parasol® Pre-Loaded Punctal Occluders Sterile

Occluders are packaged in a convenient one pair tray, are sterile and pre-loaded on a single-use inserter.



A14-201



Qty: 2/Bx

Parasol® Pre-Loaded Punctal Occluders Sterile	SKU #
X-Small, 0.25 - 0.35 mm	A14-200
Small, 0.35 - 0.65 mm	A14-201
Medium, 0.6 - 0.85 mm	A14-202
Large, 0.9 mm+	A14-203

Parasol® Quickload Punctal Occluders Sterile

Occluders are sterile and pre-mounted on a stand for Quickload convenience.



A14-201QL

Qty: 16/Bx

Parasol® Quickload Punctal Occluders Sterile	SKU #
Small, 0.35 - 0.65 mm	A14-201QL
Medium, 0.6 - 0.85 mm	A14-202QL
Large, 0.9 mm+	A14-203QL
Combo small and medium	A14-205QL

¹ C. McCabe, MD, PhD, FACSP. Plugs Reduce Dry-Eye Symptoms, Improve Vision. November 2009, Review of Ophthalmology.

Partial Occlusion

Micro Flow™ Punctal Occluders

Designed to provide a straight-forward, reversible means of partial occlusion. Micro Flow™ Punctal Occluders support lacrimal drainage care. Suggest to use when total occlusion is not ideal. Occluders are packaged in a convenient one pair tray, are sterile and pre-loaded on a single-use inserter.



A14-401



Qty: 2/Bx

Micro Flow™ Pre-Loaded Punctal Occluders Sterile	SKU #
Sterile, Small, 0.4 - 0.55 mm	A14-401
Sterile, Medium, 0.55 - 0.7 mm	A14-402
Sterile, Large, 0.7 - 0.85 mm	A14-403

Single-Use Punctal Dilators and Probes

Visitec® Punctal Dilator and Probe, Khan

Dual function instrument allows for single handed transition from dilating to probing without release of lateral lid traction.



Qty: 3/Bx

Description	SKU #
25 mm (1 in) medium taper, Blunt, Wilder style dilator mated with a size 0 Bowman lacrimal probe, 0.7 mm x 45 mm/22G x 1.75 in	585124

Other Related Occlusion Options

Lacrimal Cannula



Qty: 10/Bx
Brand: Visitec®

Description	SKU #
● 25G x 1/2 in/0.5 x 13 mm	585068

Lacrimal Cannula



Qty: 10/Bx
Brand: Visitec®

Description	SKU #
● 26G x 1-1/8 in/0.45 x 28 mm	581276

Punctum Dilator, Fine/Medium

0.4 mm x 21.5 mm Tip,
0.6 mm x 18 mm Tip,
77 mm Handle

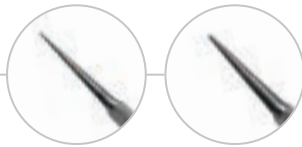

Qty: 20/Bx
Brand: Malosa®

Description	SKU #
Punctum Dilator, Fine/Medium	MMSU1181S

Punctum Dilator/Seeker

0.45 mm x 21.5 mm Tip,
5 mm Pointed tip,
18 mm Straight shaft, 77 mm Handle

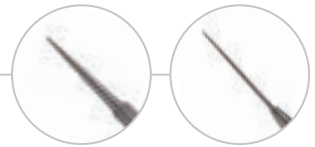

Qty: 20/Bx
Brand: Malosa®

Description	SKU #
Punctum Dilator/Seeker	MMSU1193S

Curved Tying Forceps

0.25 mm Tips, 5 mm Curved tying platforms,
80 mm Handle



Qty: 20/Bx
Brand: Malosa®

SKU# MMSU1210CS

Description	SKU #
0.25 mm Tips, 5 mm Curved tying platforms, 80 mm Handle	MMSU1210S

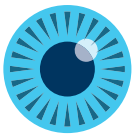

BVI

Malosa® Single-Use Packs

High Quality Instruments for Your Operating Room

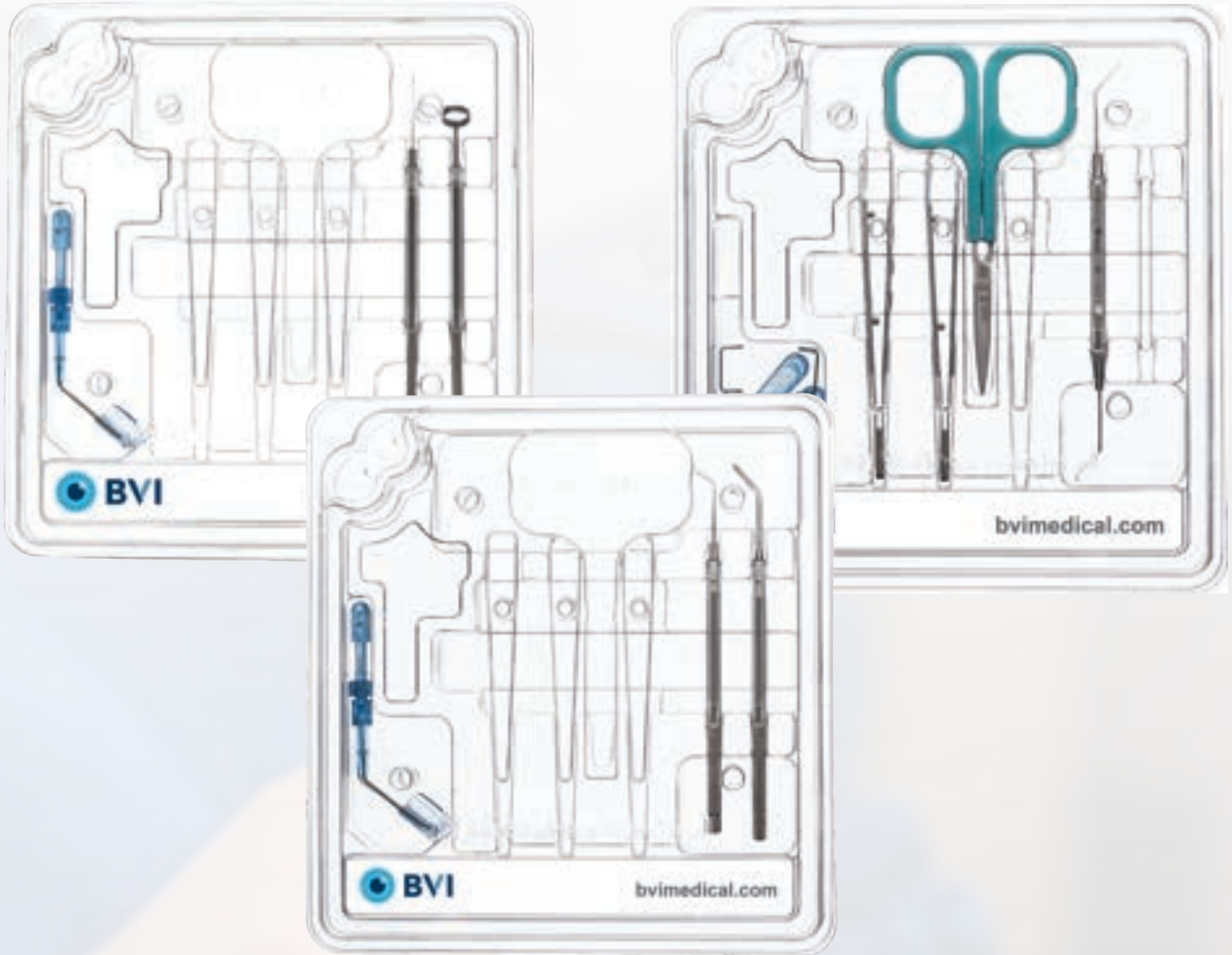

Phaco Packs

Malosa® Phaco Pack 1

Qty: 20/Bx

SKU # MMK250/2



Instruments	SKU #
MICS Capsulorhexis - Straight/Sharp	MMSU1568
Phaco Chopper/Mushroom Manipulator	MMSU1221
Fine Notched Forceps Short (Hoskins)	MMSU1114
Kratz-Barraquer Speculum	MMSU1252
Dressing Scissors Straight Rounded	MMSU0455
Straight Rampley, 18 cm	MMSU0068
Tray - 1 x Integrated Galipot	MMSU0170
Paper Wrap, 90 cm x 90 cm	MMSU0104

Refractive Packs

Malosa® Core LASIK Pack

Qty: 20/Bx

SKU # MMK100/2



Instruments	SKU #
LASIK Flap separator and elevator (Binder)	MMSU1206
Y Shape corneal marker	MMSU1134
Mechanical speculum, Solid blade (PC)	MMSU1488
Tray - Phaco tray	MMSU0174

Malosa® Core Surface Treatment Pack

Qty: 20/Bx

SKU # MMK110/3



Instruments	SKU #
Corneal epithelium spatula, Flat	MMSU1113
Epithelium well, 9 mm Trepining	MMSU1196
Mechanical speculum, Solid blade (PC)	MMSU1488
Tray - Phaco tray	MMSU0174

Corneal Packs

Malosa® Complete Corneal Cross-Linking Pack



Qty: 20/Bx

SKU # MMK462/3

Instruments	SKU #
Epithelium well, 9 mm Trephining	MMSU1196
Corneal epithelium spatula, Flat	MMSU1113
Mechanical speculum, Solid blade (PC)	MMSU1488
LASIK Cannula, Daya, 23G	MMSU1330
Syringe - 2.5 ml luer lock	MMSU0026
Non-woven gauze, 4 ply, 10 cm x 10 cm	MMSU0120
Sealed edge eye pad	MMSU0195
Syringe 2 ml luer slip	60300166
Ultraclean eye spears, Blue (Pack of 5)	8034724
Gallipot 60 ml	28033BID
Tray procedure with 2 integral gallipots	28003BID
Paper wrap, 90 cm x 90 cm	MMSU0104

Malosa® Corneal Suture Pack



Qty: 10/Bx

SKU # MMK041/3

Instruments	SKU #
Corneal needle-holder	MMSU1110
Vannas scissors, Straight	MMSU1141
Straight tying forceps	MMSU1125

IVT Packs

Malosa® Basic IVT Pack 1



Qty: 50/Bx

SKU # MMK470/1

Instruments	SKU #
Pointed IVT marker 3.5/4 mm, Blue	MMSU1277
Barraquer speculum solid blade (PC)	MMSU1475
Straight Rampley, 18 cm	MMSU0068
Non-woven gauze, 4 ply, 10 cm x 10 cm	MMSU0120
VisiSwab cotton swab 8.1 cm (3.2 in)	581069
Mini non-woven aperture drape	MMSU0514
Gallipot 60 ml	28033BID
Tray - 1 x Integrated galipot	MMSU0170
Paper wrap, 90 cm x 90 cm	MMSU0104

IVT Packs

Malosa® Basic IVT Pack 2



Qty: 50/Bx

SKU # MMK471

Instruments	SKU #
Pointed IVT marker 3.5/4 mm, Blue	MMSU1277
Barraquer speculum flat blade	MMSU1275
Straight Rampley, 18 cm	MMSU0068
Non-woven gauze, 4 ply, 10 cm x 10 cm	MMSU0120
Mini pre-cut incise drape	MMSU0520
VisiSwab cotton swab, 8.1 cm (3.2 in)	581069
Gallipot 60 ml	28033BID
Tray - 1 x Integrated galipot	MMSU0170
Paper Wrap, 90 cm x 90 cm	MMSU0104

Malosa® Core IVT Pack 1



Qty: 50/Bx

SKU # MMK877

Instruments	SKU #
Intravitreal injection guide	MMSU1577
Straight Rampley, 12.5 cm	MMSU1578
VisiSwab cotton swab, 8.1 cm (3.2 in)	581069
Needle 30G x 1/2 in	304000
Non-woven gauze, 4 ply, 10 cm x 10 cm	MMSU0120
Tray - Intravitreal tray	MMSU0166
Paper wrap, 90 cm x 90 cm	MMSU0104

Oculoplastics Packs

Malosa® Minor Oculoplastics Pack 1



Qty: 10/Bx

SKU # MMK086

Instruments	SKU #
Disposable scalpel with guard blade no. 15	8034669
Castroviejo needle-holder, Straight	MMSU3012
Bishops forceps	MMSU0276
Westcott scissors curved dolphin nose	MMSU1213

Oculoplastics Packs

Malosa® Minor Oculoplastics Pack 2



Qty: 10/Bx

SKU # MMK178

Instruments	SKU #
Stevens tenotomy, Straight, Rounded	MMSU0214
Adson forceps toothed	MMSU0238
Halstead mosquito, Fine, Straight	MMSU3008
St Martins forceps	MMSU0279
Castroviejo needle-holder, Straight	MMSU3012

Malosa® Oculoplastic Suture Pack 1



Qty: 10/Bx

SKU # MMK037/1

Instruments	SKU #
Corneal needle-holder	MMSU1110
St Martins forceps	MMSU0279
Dressing scissors, Straight, Pointed	MMSU0454

Malosa® Oculoplastic Suture Pack 2



Qty: 10/Bx

SKU # MMK072

Instruments	SKU #
Straight tying forceps	MMSU1125
Troutman needle-holder	MMSU1243
Westcott scissors, Straight, Pointed	MMSU1214

Malosa® Suture Removal Pack 1



Qty: 20/Bx

SKU # MMK0303/1

Instruments	SKU #
Adson forceps, Non-toothed	MMSU0241
Dressing scissors, Curved, Pointed	MMSU0441
Non-woven gauze, 4 ply, 10 cm x 10 cm	MMSU0120
Gallipot 60 ml	28033BID
Tray - 1 x Integrated gallipot	MMSU0170
Paper wrap, 50 cm x 50 cm	MMSU0137

Chalazion Packs

Malosa® Chalazion Pack 1



Qty: 20/Bx

SKU # MMK133

Instruments	SKU #
Disposable scalpel with guard blade no. 11	8034668
Chalazion clamp round	MMSU1150
Chalazion curette, Double, 2 mm/3 mm	MMSU1158

Malosa® Chalazion Pack 2



Qty: 20/Bx

SKU # MMK132

Instruments	SKU #
Disposable scalpel with guard blade no. 11	8034668
Chalazion clamp round	MMSU1150
Chalazion curette, Double, 1 mm/2 mm	MMSU1157

Blepharoplasty Packs

Malosa® Blepharoplasty Pack



Qty: 10/Bx

SKU # MMK062

Instruments	SKU #
Disposable scalpel with guard blade no. 15	8034669
Westcott scissors curved dolphin nose	MMSU1213
Corneal needle-holder	MMSU1110
St Martins forceps	MMSU0279

Malosa® Blepharoplasty Pack 2



Qty: 10/Bx

SKU # MMK165

Instruments	SKU #
Disposable scalpel with guard blade no. 11	8034669
Corneal needle-holder	MMSU1110
Straight tying forceps	MMSU1125
Westcott scissors curved dolphin nose	MMSU1213
St Martins forceps	MMSU0279

Sub Tenons Pack

Malosa® Sub-Tenons Pack 1



Qty: 10/Bx

SKU # MMK106

Instruments	SKU #
Moorfields forceps	MMSU0277
Westcott scissors curved dolphin nose	MMSU1213
Barraquer speculum flat blade	MMSU1275

Retinal Packs

Malosa® Paediatric Retinal Exam Pack



Qty: 20/Bx

SKU # MMK484

Instruments	SKU #
Neonatal speculum, Small	MMSU1262
Curved scleral depressor	MMSU1409

Malosa® Vitrectomy Access Pack



Qty: 20/Bx

SKU # MMK261/2

Instruments	SKU #
Moorfields forceps	MMSU0277
Pointed IVT marker 3.5/4 mm, Blue	MMSU1277
VR Double-ended depressor/indenter	MMSU1407
Westcott scissors curved dolphin nose	MMSU1213
Fine notched forceps short (Hoskins)	MMSU1114
Mechanical speculum open blade (PC)	MMSU1290
Dressing Scissors, Straight, Rounded	MMSU0455
Tray - 1 × Integrated galipot	MMSU0170
Paper wrap, 50 cm × 50 cm	MMSU0137

Retinal Packs

Malosa® Cryo and Buckle Access Pack

Qty: 20/Bx

SKU # MMK262/1



Instruments	SKU #
Curved muscle hook	MMSU0253
Dressing scissors straight rounded	MMSU0455
Fine notched forceps short (Hoskins)	MMSU1114
Fisons retractor	MMSU3038
Halstead mosquito fine curved	MMSU3007
Mechanical speculum open blade (PC)	MMSU1290
Micro cross-action bulldog clamp	MMSU0199
Moorfields forceps	MMSU0277
St Martins forceps	MMSU0279
Toothed forceps (Bonn)	MMSU1124
VR Double-ended depressor/indenter	MMSU1407
Westcott scissors curved dolphin nose	MMSU1213

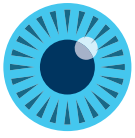

BVI

IOL Portfolio

Intraocular Solutions Overview



Trifocal Toric Hydrophobic

FINEVISION HP

TRIFOCAL OPTIC

TORIC

G-FREE

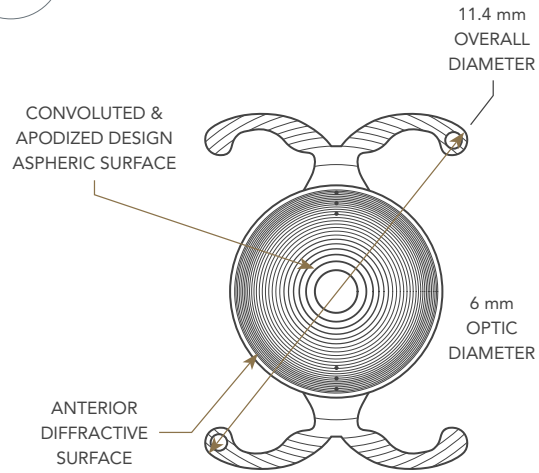

Model	POD FT 49P							
Material	GFY Hydrophobic Acrylic ¹							
Overall diameter	11.4 mm							
Optic diameter	6 mm							
Optic	Biconvex Aspheric Toric Trifocal							
Haptic design	POD (Double C-loop) with Ridgetech® & Posterior Angulated Haptic							
Filtration	UV & Blue Light							
Refractive index	1.53							
Abbe number	42							
Additional power (IOL plane)	+1.75D & +3.50D							
Injection system	Medicel Accuject 2.1/2.2							
Spherical power ⁴	+10D to +35D (0.5D steps)							
Cylinder power (IOL plane) ⁴	1.00 - 1.50 - 2.25 - 3.00 - 3.75 - 4.50 - 5.25 - 6.00D							
Suggested A constant ²					Interferometry			
	Hoffer Q: pACD				5.85			
	Holladay 1: Sf				2.06			
	Barrett: LF				2.09			
	SRK/T: A				119.40			
	Haigis³: a0; a1; a2				1.70; 0.4; 0.1			
	POD FT 49P 1.0	POD FT 49P 1.5	POD FT 49P 2.25	POD FT 49P 3.0	POD FT 49P 3.75	POD FT 49P 4.5	POD FT 49P 5.25	POD FT 49P 6.0
Cylinder power at IOL plane	1.00D	1.50D	2.25D	3.00D	3.75D	4.50D	5.25D	6.00D
Cylinder power at corneal plane ⁵	0.68D	1.03D	1.55D	2.06D	2.57D	3.08D	3.60D	4.11D

TORIC CALCULATOR: WWW.PHYSIOLTORIC.EU

¹ The PhysiOL GFY® is patented since 2010. Patent number: EP1830898. | ² Values estimated only; surgeons are recommended to personalize their A-constant based on their surgical techniques and equipment, experience with the lens model and postoperative results. | ³ Not optimized. | ⁴ Please check the availability of spherical and cylinder powers with your sales representative. | ⁵ Savini G., J Cataract Refract Surg 2013; 39:1900–1903.

Trifocal Toric Hydrophilic

FINEVISION
TRIFOCAL OPTIC

TORIC

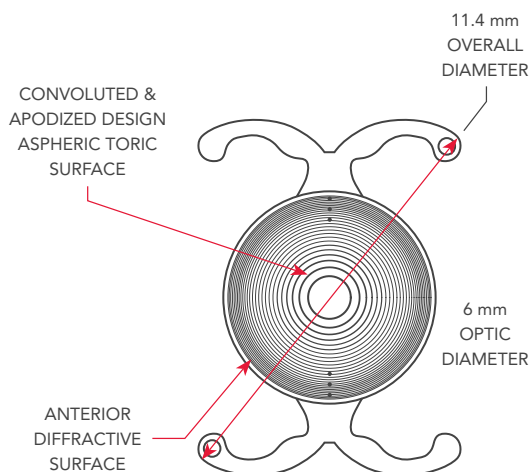

Model	POD FT							
Material	26% Hydrophilic Acrylic							
Overall diameter	11.4 mm							
Optic diameter	6 mm							
Optic	Biconvex Aspheric Toric Trifocal							
Haptic design	POD (Double-C-loop) haptic design & Posterior Angulated Haptic							
Filtration	UV & Blue Light							
Refractive index	1.46							
Abbe number	58							
Additional power (IOL plane)	+1.75D & +3.50D							
Injection system	Medicel Accuject 2.0 up to 24.5D and Medicel Accuject 2.1/2.2 up to 35D							
Spherical power ³	+6D to +35D (0.5D steps)							
Cylinder power (IOL plane) ³	1.00 - 1.50 - 2.25 - 3.00 - 3.75 - 4.50 - 5.25 - 6.00D							
Suggested A constant ¹					Interferometry			
	Hoffer Q: pACD				5.59			
	Holladay 1: Sf				1.83			
	Barrett: LF				1.86			
	SRK/T: A				118.95			
	Haigis²: a0; a1; a2				1.36; 0.4; 0.1			
Cylinder power at IOL plane	POD FT 1.0	POD FT 1.5	POD FT 2.25	POD FT 3.0	POD FT 3.75	POD FT 4.5	POD FT 5.25	POD FT 6.0
	1.00D	1.50D	2.25D	3.00D	3.75D	4.50D	5.25D	6.00D
Cylinder power at corneal plane ⁴	0.68D	1.03D	1.55D	2.06D	2.57D	3.08D	3.60D	4.11D

TORIC CALCULATOR: WWW.PHYSIOLTORIC.EU

¹ Values estimated only; surgeons are recommended to personalize their A-constant based on their surgical techniques and equipment, experience with the lens model and postoperative results. | ² Not optimized. | ³ Please check the availability of spherical and cylinder powers with your sales representative. | ⁴ Savini G., J Cataract Refract Surg 2013; 39:1900–1903.

Trifocal Hydrophobic

FINEVISION HP

TRIFOCAL OPTIC

G-FREE

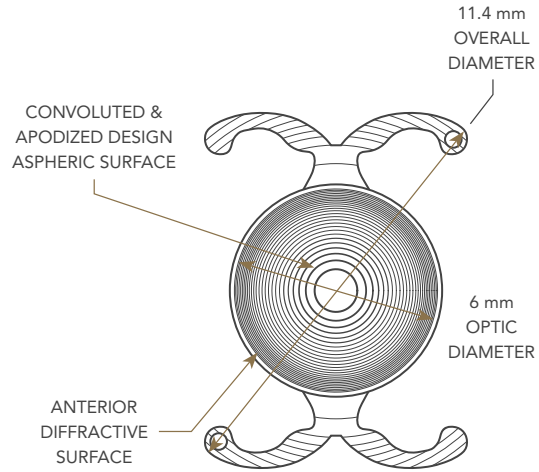

Model	POD F GF	
Material	GFY Hydrophobic Acrylic ¹	
Overall diameter	11.4 mm	
Optic diameter	6 mm	
Optic	Biconvex Aspheric Trifocal	
Haptic design	POD (Double C-loop) with Ridgetech® & Posterior Angulated Haptic	
Filtration	UV & Blue Light	
Refractive index	1.53	
Abbe number	42	
Additional power (IOL plane)	+1.75D & +3.50D	
Injection system	Medicel Accuject 2.0 up to 24.5D Medicel Accuject 2.1/2.2 up to 35D	
Spherical power ⁴	+10D to +35D (0.5D steps)	
Suggested A constant ²	Interferometry	
	Hoffer Q: pACD	5.85
	Holladay 1: Sf	2.06
	Barrett: LF	2.09
	SRK/T: A	119.40
	Haigis ³ : a0; a1; a2	1.70; 0.4; 0.1

¹ The PhysIOL GFY® is patented since 2010. Patent number: EP1830898. | ² Values estimated only; surgeons are recommended to personalize their A-constant based on their surgical techniques and equipment, experience with the lens model and postoperative results. | ³ Not optimized. | ⁴ Please check the availability of spherical powers with your sales representative.

Trifocal Hydrophilic

FINEVISION

TRIFOCAL OPTIC

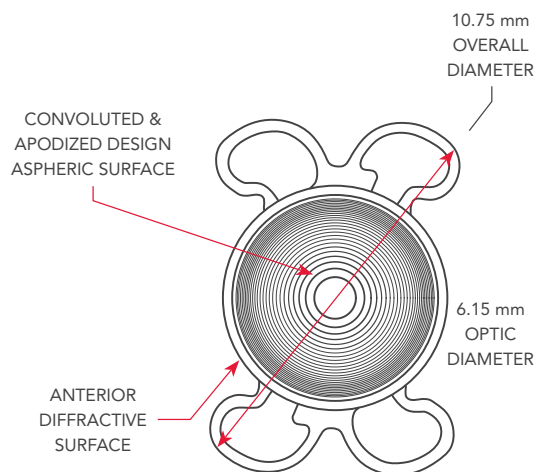

Model	MICRO F	
Material	25% Hydrophilic Acrylic	
Overall diameter	10.75 mm	
Optic diameter	6.15 mm	
Optic	Biconvex Aspheric Trifocal	
Haptic design	MICRO (closed loop quadripode) & Posterior Angulated Haptic	
Filtration	UV & Blue Light	
Refractive index	1.46	
Abbe number	58	
Additional power (IOL plane)	+1.75D & +3.50D	
Injection system	Medical Viscoject Bio 1.8 / Accuject 1.8 up to 24.5D Medical Accuject 2.0/2.1/2.2 up to 35D	
Spherical power ³	+10D to +35D (0.5D steps)	
Suggested A constant ¹	Interferometry	
	Hoffer Q: pACD	5.35
	Holladay 1: Sf	1.60
	Barrett: LF	1.78
	SRK/T: A	118.80
Haigis ² : a0; a1; a2	1.36; 0.4; 0.1	

¹ Values estimated only: surgeons are recommended to personalize their A-constant based on their surgical techniques and equipment, experience with the lens model and postoperative results. | ² Not optimized. | ³ Please check the availability of spherical powers with your sales representative.

Trifocal Hydrophilic

FINEVISION

TRIFOCAL OPTIC

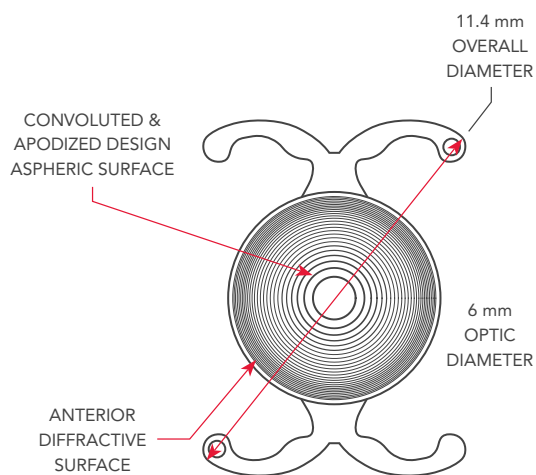

Model	POD F
Material	26% Hydrophilic Acrylic
Overall diameter	11.4 mm
Optic diameter	6 mm
Optic	Biconvex Aspheric Trifocal
Haptic design	POD (Double-C-loop) haptic design & Posterior Angulated Haptic
Filtration	UV & Blue Light
Refractive index	1.46
Abbe number	58
Additional power (IOL plane)	+1.75D & +3.50D
Injection system	Medicel Accuject 2.0 up to 24.5D Medicel Accuject 2.1/2.2 up to 35D
Spherical power ³	+6D to +35D (0.5D steps)

¹ Values estimated only: surgeons are recommended to personalize their A-constant based on their surgical techniques and equipment, experience with the lens model and postoperative results. | ² Not optimized. | ³ Please check the availability of spherical powers with your sales representative.

Premium Monofocal

ISOPURE

Uncompromised. Extended. Simplified.

1.2.3

G-FREE

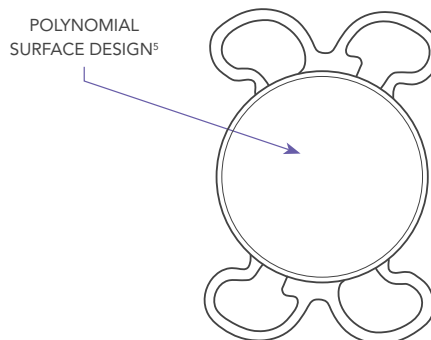

Model	ISOPURE 123	
Material	GFY Hydrophobic Acrylic ¹	
Overall diameter	10D to 24.5D: 11 mm 25D to 30D: 10.75 mm	
Optic diameter	10D to 24.5D: 6 mm 25D to 30D: 5.75 mm	
Optic	Polynomial Surface Design	
Haptic design	MICRO (closed loop quadripode) & Posterior Angulated Haptic	
Filtration	UV & Blue Light	
Refractive index	1.53	
Abbe number	42	
Injection system	SINGLE-USE INJECTOR 1.2.3 PREMIUM	
Spherical power⁴	+10D to +30D (0.5D steps) Cartridge with PRS [®] technology	
Suggested A constant²		Interferometry
	Hoffer Q: pACD	5.85
	Holladay 1: Sf	2.06
	Barrett: LF	2.09
	SRK/T: A	119.40
	Haigis³: a0; a1; a2	1.70; 0.4; 0.1
	ISOPURE	
Overall diameter	10.75 mm	
Optic diameter	5.75 mm	
Injection system	Medical Accuject 2.0 / 2.1 / 2.2 mm	
Spherical power⁴	+31D to +35D (1D steps)	

¹ The PhysIOL GFY[®] is patented since 2010. Patent number: EP1830898. | ² Values estimated only; surgeons are recommended to personalize their A-constant based on their surgical techniques and equipment, experience with the lens model and postoperative results. | ³ Not optimized. | ⁴ Please check the availability of spherical powers with your sales representative.

Monofocal Toric Hydrophobic

PODEYE
MONOFOCAL OPTIC

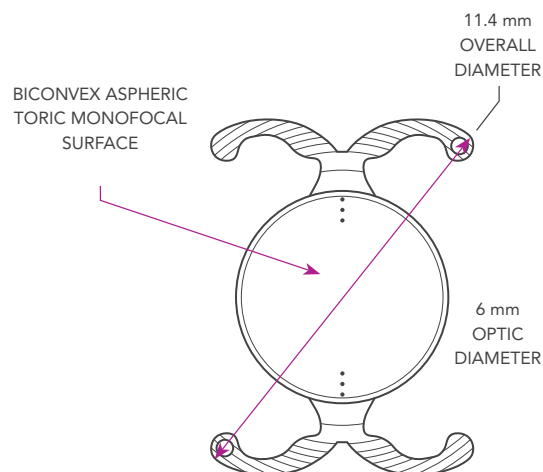

Model	PODEYE TORIC							
Material	GFY Hydrophobic Acrylic ¹							
Overall diameter	11.4 mm							
Optic diameter	6 mm							
Optic	Biconvex Aspheric Toric Monofocal							
Haptic design	POD (Double-C-loop) haptic design & Posterior Angulated Haptic							
Filtration	UV & Blue Light							
Refractive index	1.53							
Abbe number	42							
Injection system	Medicel Accuject 2.1 / 2.2							
Spherical power ⁴	+6D to +30D (0.5D steps)							
Cylinder power (IOL plane) ⁴	1.00 - 1.50 - 2.25 - 3.00 - 3.75 - 4.50 - 5.25 - 6.00D							
Suggested A constant ²					Interferometry			
	Hoffer Q: pACD				5.85			
	Holladay 1: Sf				2.06			
	Barrett: LF				2.09			
	SRK/T: A				119.40			
	Haigis³: a0; a1; a2				1.70; 0.4; 0.1			
Cylinder power at IOL plane	PODEYE TORIC 1.0	PODEYE TORIC 1.5	PODEYE TORIC 2.25	PODEYE TORIC 3.0	PODEYE TORIC 3.75	PODEYE TORIC 4.5	PODEYE TORIC 5.25	PODEYE TORIC 6.0
	1.00D	1.50D	2.25D	3.00D	3.75D	4.50D	5.25D	6.00D
Cylinder power at corneal plane ⁵	0.68D	1.03D	1.55D	2.06D	2.57D	3.08D	3.60D	4.11D

TORIC CALCULATOR: WWW.PHYSIOLTORIC.EU

¹ The PhysiOL GFY® is patented since 2010. Patent number: EP1830898. | ² Values estimated only; surgeons are recommended to personalize their A-constant based on their surgical techniques and equipment, experience with the lens model and postoperative results. | ³ Not optimized. | ⁴ Please check the availability of spherical and cylinder powers with your sales representative. | ⁵ Savini G., J Cataract Refract Surg 2013; 39:1900–1903.

Monofocal Toric Hydrophilic

ANKORIS
MONOFOCAL OPTIC

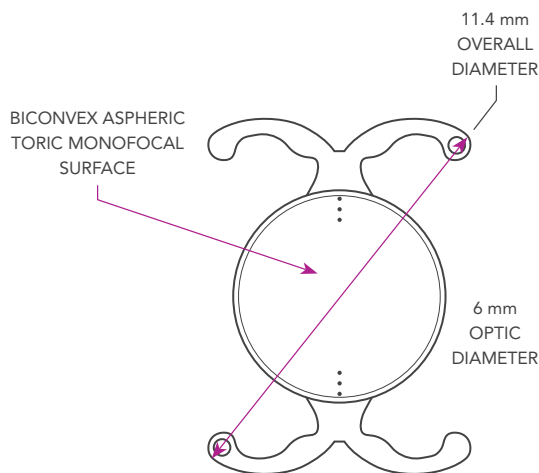

Model	ANKORIS						
Material	26% Hydrophilic Acrylic						
Overall diameter	11.4 mm						
Optic diameter	6 mm						
Optic	Biconvex Aspheric Toric Monofocal						
Haptic design	POD (Double-C-loop) haptic design & Posterior Angulated Haptic						
Filtration	UV & Blue Light						
Refractive index	1.46						
Abbe number	58						
Injection system	Medicel Accuject 2.0 up to 24.5D & Medicel Accuject 2.1/2.2 up to 30D						
Spherical power³	+6D to +30D (0.5D steps)						
Cylinder power (IOL plane)³	1.50 - 2.25 - 3.00 - 3.75 - 4.50 - 5.25 - 6.00D						
Suggested A constant¹				Interferometry			
	Hoffer Q: pACD			5.59			
	Holladay 1: Sf			1.83			
	Barrett: LF			1.86			
	SRK/T: A			118.95			
	Haigis²: a0; a1; a2			1.36; 0.4; 0.1			
Cylinder power at IOL plane	ANKORIS 1.5	ANKORIS 2.25	ANKORIS 3.0	ANKORIS 3.75	ANKORIS 4.5	ANKORIS 5.25	ANKORIS 6.0
	1.50D	2.25D	3.00D	3.75D	4.50D	5.25D	6.00D
Cylinder power at corneal plane⁴	1.03D	1.55D	2.06D	2.57D	3.08D	3.60D	4.11D

TORIC CALCULATOR: WWW.PHYSIOLTORIC.EU

¹ Values estimated only: surgeons are recommended to personalize their A-constant based on their surgical techniques and equipment, experience with the lens model and postoperative results. | ² Not optimized. | ³ Please check the availability of spherical and cylinder powers with your sales representative. | ⁴ Savini G., J Cataract Refract Surg 2013; 39:1900–1903.

Preloaded Monofocal Hydrophobic

MICROPURE

MONOFOCAL OPTIC

1.2.3

G-FREE



BICONVEX ASPHERIC
MONOFOCAL
SURFACE

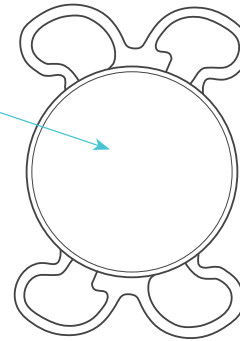

Model	MICROPURE 123	
Material	GFY Hydrophobic Acrylic ¹	
Overall diameter	0D to 24.5D: 11 mm 25D to 30D: 10.75 mm	
Optic diameter	0D to 24.5D: 6 mm 25D to 30D: 5.75 mm	
Optic	Biconvex Aspheric Monofocal	
Haptic design	MICRO (closed loop quadripode) & Posterior Angulated Haptic	
Filtration	UV & Blue Light	
Refractive index	1.53	
Abbe number	42	
Injection system	SINGLE-USE INJECTOR 1.2.3 PREMIUM	
Spherical power ⁴	0D to +9D (1D steps) & +10D to +30D (0.5D steps) Cartridge with PRS technology	
Suggested A constant ²	Interferometry	
	Hoffer Q: pACD	5.85
	Holladay 1: Sf	2.06
	Barrett: LF	2.09
	SRK/T: A	119.40
	Haigis ³ : a0; a1; a2	1.70; 0.4; 0.1

¹ The PhysIOL GFY® is patented since 2010. Patent number: EP1830898. | ² Values estimated only; surgeons are recommended to personalize their A-constant based on their surgical techniques and equipment, experience with the lens model and postoperative results. | ³ Not optimized. | ⁴ Please check the availability of spherical powers with your sales representative.

Monofocal Hydrophobic

MICROPURE

MONOFOCAL OPTIC

G-FREE



BICONVEX ASPHERIC
MONOFOCAL
SURFACE

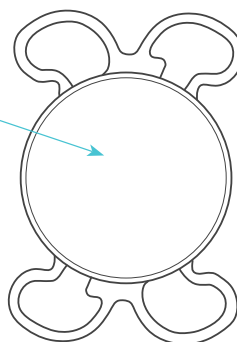

Model	MICROPURE	
Material	GFY Hydrophobic Acrylic ¹	
Overall diameter	-10D to 24.5D: 11 mm 25D to 35D: 10.75 mm	
Optic diameter	-10D to 24.5D: 6 mm 25D to 35D: 5.75 mm	
Optic	Biconvex Aspheric Monofocal	
Haptic design	MICRO (closed loop quadripode) & Posterior Angulated Haptic	
Filtration	UV & Blue Light	
Refractive index	1.53	
Abbe number	42	
Injection system	Medicel Accuject 1.8 up to 24.5D Medicel Accuject 2.0/2.1/2.2 up to 35D	
Spherical power ⁴	-10D to +9D (1D steps) +10D to +30D (0.5D steps) +31D to +35D (1D steps)	
Suggested A constant ²	Interferometry	
	Hoffer Q: pACD	5.85
	Holladay 1: Sf	2.06
	Barrett: LF	2.09
	SRK/T: A	119.40
	Haigis ³ : a0; a1; a2	1.70; 0.4; 0.1

¹ The PhysIOL GFY® is patented since 2010. Patent number: EP1830898. | ² Values estimated only; surgeons are recommended to personalize their A-constant based on their surgical techniques and equipment, experience with the lens model and postoperative results. | ³ Not optimized. | ⁴ Please check the availability of spherical powers with your sales representative.

Monofocal Hydrophobic

PODEYE
MONOFOCAL OPTIC

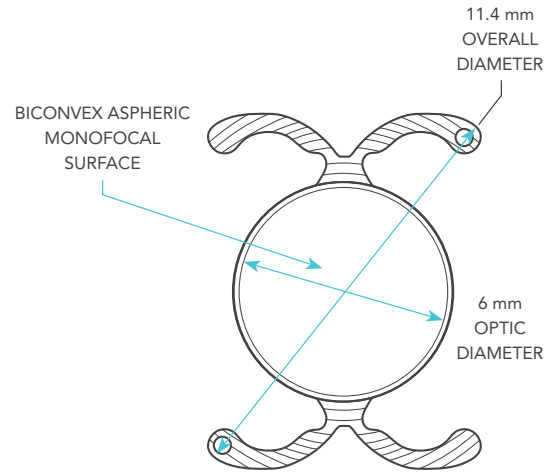

Model	PODEYE	
Material	GFY Hydrophobic Acrylic ¹	
Overall diameter	11.4 mm	
Optic diameter	6 mm	
Optic	Biconvex Aspheric Monofocal	
Haptic design	POD (Double-C-loop) haptic design & Posterior Angulated Haptic	
Filtration	UV & Blue Light	
Refractive index	1.53	
Abbe number	42	
Injection system	Medicel Accuject 2.0 up to 24.5D Medicel Accuject 2.1/2.2 up to 35D	
Spherical power ⁴	+10D to +30D (0.5D steps) 0D to +9D & +31D to +35D (1D steps)	
Suggested A constant ²	Interferometry	
	Hoffer Q: pACD	5.85
	Holladay 1: Sf	2.06
	Barrett: LF	2.09
	SRK/T: A	119.40
	Haigis ³ : a0; a1; a2	1.70; 0.4; 0.1

¹ The PhysiOL GFY® is patented since 2010. Patent number: EP1830898. | ² Values estimated only: surgeons are recommended to personalize their A-constant based on their surgical techniques and equipment, experience with the lens model and postoperative results. | ³ Not optimized. | ⁴ Please check the availability of spherical powers with your sales representative.

Product Families

PREMIUM TRIFOCAL HYDROPHOBIC

FINEVISION HP
TRIFOCAL OPTIC
(POD FT 49P)

TORIC G-FREE

FINEVISION HP
TRIFOCAL OPTIC
(POD F GF)

G-FREE

PREMIUM TRIFOCAL HYDROPHILIC

FINEVISION
TRIFOCAL OPTIC
(POD FT)

TORIC

FINEVISION
TRIFOCAL OPTIC
(MICRO F)

FINEVISION
TRIFOCAL OPTIC
(POD F)

PREMIUM MONOFOCAL

ISOPURE
Uncompromised. Extended. Simplified.

1.2.3 G-FREE

ISOPURE
Uncompromised. Extended. Simplified.

G-FREE

MONOFOCAL TORIC

PODEYE
MONOFOCAL OPTIC
(POD T 49P)

TORIC G-FREE

ANKORIS
MONOFOCAL OPTIC

TORIC

MONOFOCAL

MICROPURE
MONOFOCAL OPTIC

1.2.3 G-FREE

MICROPURE
MONOFOCAL OPTIC

G-FREE

PODEYE
MONOFOCAL OPTIC

G-FREE

INJECTION SYSTEM

1.2.3 Premium



Medicel Accuject / Viscoject

Note :

The intraocular lenses are not FDA approved. Please check the lens availability with your sales representative.

G-FREE Tested under in vitro conditions as reported in *Assessment of new-generation glistening-free hydrophobic acrylic intraocular lens material*, C. Pagnouille, D. Bozukova, L. Gobin, V. Bertrand, M.-C. Gillet-DePauw, JCRS 2013, 38, 1271-1277

Product Categories

GFY hydrophobic material

FINEVISION HP  
TRIFOCAL OPTIC

FINEVISION HP 
TRIFOCAL OPTIC

ISOPURE 
Uncompromised. Extended. Simplified.

ISOPURE  
Uncompromised. Extended. Simplified.

PODEYE  
MONOFOCAL OPTIC

MICROPURE 
MONOFOCAL OPTIC

MICROPURE  
MONOFOCAL OPTIC

PODEYE 
MONOFOCAL OPTIC

Hydrophilic material

FINEVISION  FINEVISION 
TRIFOCAL OPTIC TRIFOCAL OPTIC
(MICRO F) (POD F)

FINEVISION 
TRIFOCAL OPTIC

ANKORIS 
MONOFOCAL OPTIC

Note :

The intraocular lenses are not FDA approved. Please check the lens availability with your sales representative.



Tested under in vitro conditions as reported in *Assessment of new-generation glistening-free hydrophobic acrylic intraocular lens material*, C. Pagnouille, D. Bozukova, L. Gobin, V. Bertrand, M.-C. Gillet-DePauw, JCRS 2013, 38, 1271-1277

Product Categories

POD Platform

FINEVISION HP  
TRIFOCAL OPTIC

FINEVISION HP 
TRIFOCAL OPTIC

FINEVISION 
TRIFOCAL OPTIC

FINEVISION (POD F)
TRIFOCAL OPTIC

PODEYE  
MONOFOCAL OPTIC

ANKORIS 
MONOFOCAL OPTIC

PODEYE 
MONOFOCAL OPTIC



MICRO Platform

FINEVISION (MICRO F)
TRIFOCAL OPTIC

ISOPURE 
Uncompromised. Extended. Simplified.

ISOPURE  
Uncompromised. Extended. Simplified.

MICROPURE 
MONOFOCAL OPTIC

MICROPURE  
MONOFOCAL OPTIC



Note :

The intraocular lenses are not FDA approved. Please check the lens availability with your sales representative.

 Tested under in vitro conditions as reported in *Assessment of new-generation glistening-free hydrophobic acrylic intraocular lens material*, C. Pagnouille, D. Bozukova, L. Gobin, V. Bertrand, M.-C. Gillet-DePauw, JCRS 2013, 38, 1271-1277

Toric Calculator

Online **Toric Calculator** with Abulafia-Koch regression formula

How to achieve the most accurate correction for your astigmatic patients?

Our goal is to assist surgeons with precise and reliable IOL calculations. The new calculation method informs physicians about the appropriate toric IOL model and as such improves toric outcomes in astigmatic patients.

What are the new features?

- 1 Abulafia-Koch regression Formula, which reportedly theoretically accounts for posterior corneal astigmatism. This calculation method uses the standard keratometry measurements (anterior K values) and estimates the total corneal astigmatism based on the Abulafia-Koch regression Formula to improve the prediction of postoperative astigmatic outcome. Calculation using the Standard K method is still possible.
- 2 HELP-button at each bloc that will help you understand and fill in each parameter.
- 3 Predictive patient-specific effective lens position (ELP)

The calculator still offers the possibility to use the Standard K calculation method as with the previous version.

The screenshot shows the PhysiOL Toric Calculator interface. Three callouts point to specific features:

- 1** Abulafia-Koch regression Formula: Points to the 'Calculation Method' dropdown menu where 'Abulafia-Koch regression' is selected.
- 2** HELP-button: Points to a small circular icon with a question mark located next to the 'Calculation Method' dropdown.
- 3** Predictive patient-specific effective lens position: Points to the 'Effective Lens Position' field in the 'Biometry' section.

The interface includes sections for 'Patient History', 'Pre-surgery Details', 'Biometry', and 'Calculation Parameters'. A diagram of an eye cross-section is visible on the right side of the calculator.

Toric Calculator

www.physioltoric.eu



Innovative Ophthalmic Equipment and Instruments

Supporting Endoscopic CycloPhotocoagulation (ECP), Phaco and Vitreoretinal procedures

BVI offers a synthesis of advanced equipment providing functionality and reliability using innovative technologies to meet surgical requirements with a continued evolution of hardware and software options.



Endo Optiks®

Laser Endoscopy System

The E2 and E4 endoscopy systems provide high resolution video imaging and wide field illumination. All endoscopes and probes are for use with these systems.

E2 Ophthalmic Laser Endoscopy System

The E2 system uniquely combines endoscopic imaging and laser treatment capability. The console houses a high resolution video camera, 175 or 300 watt xenon light source and an 810nm diode laser. It offers versatility like no other ophthalmic surgical instrument with targeted, controlled laser delivery for the treatment of glaucoma and retinal disorders and valuable diagnostic imaging.



Description	SKU #
E2 Compact Microprobe Laser And Endoscopy System, 1/Ea	OME2000

E4 Ophthalmic Endoscopy System

The E4 high resolution endoscopy system can be coupled with various external lasers for triple function laser endoscopy.



Description	SKU #
E4 Ophthalmic Laser Endoscopy System, 1/Ea	OME4000

Microendoscopes and Probes

Triple Function Ophthalmic Laser Endoscopes



SKU #	G	Cannula	High Resolution	Laser	Camera	Light	Custom Laser Connection	E2 Compatibility	E4 Compatibility
OME200SMAVA	19	Curved	✓	✓	✓	✓		✓	
OME200SMAXVA	19	Curved	✓	✓	✓	✓	✓	✓	✓
OME200SMAHRA	19	Straight	✓	✓	✓	✓		✓	
OME200SMAHRVA	19	Curved	✓	✓	✓	✓		✓	
OME200SMAHRXA	19	Straight	✓	✓	✓	✓	✓	✓	✓
OME200SMAHRXVA	19	Curved	✓	✓	✓	✓	✓	✓	✓
OME200SMAEA	20	Straight		✓	✓	✓		✓	
OME200SMAXA	20	Straight		✓	✓	✓	✓	✓	✓
OME230SMAHRXA	23	Straight	✓	✓	✓	✓	✓	✓	✓

Endo Optiks®

Dual Function Ophthalmic Endoscopes

SKU #	G	Cannula	High Resolution	Laser	Camera	Light	Custom Laser Connection	E2 Compatibility	E4 Compatibility
OME200HRA	20	Straight	✓		✓	✓		✓	✓
OME230HRA	23	Straight	✓		✓	✓		✓	✓

Endo Optiks® Accessories

Diode Laser Safety Goggles

810nm diode laser safety goggles for use with/without eyeglasses.



Description	SKU #
Diode laser safety goggles, 1/Ea	LG001

Endoscope Tip Protector

Polycarbonate protector tube for 23G endoscope cannulas (not autoclavable).



Description	SKU #
Tip protector for 23G endoscope, 1/Ea	NC001-A

Endoscope Connector Caps

Protective caps for endoscope light, camera and laser connectors.



Description	SKU #
Endoscope connector caps, 50/Ea Video/light and 10/Ea Laser, 1/Ea	EO-CAP-S

Flight Case

Custom foam padded flight cases with wheels and telescoping handles.



Description	SKU #
Flight case with built-in wheels and telescoping handle for E4 Unit, 1/Ea	FC2720
Flight case with built-in wheels and telescoping handle for E2 Unit, 1/Ea	FC401655

Endo Optiks® Accessories

Footswitches

Non-slip laser energy control for E2 system. Optional illumination control via side paddles compatible with E2 and E4.

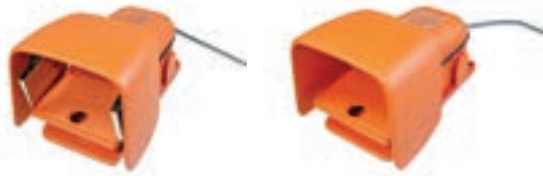

Description	SKU #
Footswitch with illumination and laser control, 1/Ea	SW002
Footswitch for laser only, 1/Ea	SW003

Video Adapters

These couplers offer optimum zoom and manual focus of the endoscopic image. 810nm laser filters installed in all models with 532nm options available.



Description	SKU #
17K Pixel video adapter (for use with 17K high resolution endoscopes), for use with E2 Ophthalmic Laser Endoscopy System, 1/Ea	OME170Z
17K Pixel video adapter (for use with 17K high res. endoscopes), for use with E4 Ophthalmic Laser Endoscopy System, 1/Ea	OME170ZMG
10K Video adapter with 532Nm and 810Nm filter (for use with 10K endoscopes), 1/Ea	OME300ZMG

Monitors

7 x 11 in Single layer tray with rubber fingered mat for all endoscopes and probes.



Description	SKU #
Operating room system cart with integrated monitor arm	CT003
26 in Medical grade monitor enhanced brightness and contrast (Order Ct002-FPA with this monitor - no stand included), 1/Ea	MON006
17 in Medical grade high resolution LCD flat screen, 1/Ea	MON007

Sterilization Tray

Medical grade monitors offered specifically to achieve optimum quality of the endoscopic image and compatibility with E2, E4 and mounting arm.

Description	SKU #
Sterilization tray	VP6250

Surgical Equipment

R-Evolution®

R-Evolution® Ophthalmic Equipment is available in two configurations for cataract and for cataract and vitreoretinal surgery. R-Evolution® offers a wide range of options to amplify surgeon's talent in each step of the procedure, including: AGILE™ Fluidics Control with IOP management through Advanced Microprocessor-controlled active infusion and the proprietary algorithm "Dynamic IOP control" acting synergistically to mitigate surge and IOP fluctuations by adjusting IOP in response to varying aspiration demand. Moreover the equipment offers switchable flow/vacuum based aspiration modalities. Optimised Energy Management with Minimal Stress technology for consistent phaco tip elongation regardless of cataract grade and multiple proven U/S power emission protocols through a wide portfolio of proprietary phaco tip and 40 KHz phaco hand-piece. For vitreoretinal application, it offers a wide range of single use devices to support 23G, 25 and 27G procedures and built in LED Lighting System with three independent LED light sources with selectable colour filters for enhanced visualization, free of harmful UV and IR emissions, and integrated Green Laser Module 532 nm for endo-photocoagulation.

User Interface: Large and high visibility 19" touch screen, wireless foot-pedal programmable as single or dual linear, programmable voice and audio fee-back and remote control.



Equipment for Cataract/Vitreoretinal Surgery

Description	SKU #
R-Evolution® CR	121012
Integrated endo-laser upgrade for R-Evolution® CR	128910

Equipment for Cataract Surgery

Description	SKU #
R-Evolution® (Peristaltic and rotary vane pumps)	111012

Surgical Equipment

R-Evo Smart®

R-Evo Smart® is a convenient compact modular system for cataract surgeons, fusing performances and functionality and capable of supporting also posterior segment procedures. It is designed in 3 configurations with peristaltic pump only (R-Evo Smart® E), dual pump for anterior segment surgery only (R-Evo Smart® S) and dual pump for anterior and posterior segment surgery (R-Evo Smart® CR).

R-Evo Smart® offers access to a wide portfolio of single-use and reusable devices to support anterior and posterior eye-segment procedures. R-Evo Smart® features: AGILE™ Fluidics Control with IOP management through Advanced Microprocessor-controlled active infusion and the proprietary algorithm "Dynamic IOP control" acting synergistically to mitigate surge and IOP fluctuations by adjusting IOP in response to varying aspiration demand. Moreover the equipment offers switchable flow/vacuum based aspiration modalities. Optimised Energy Management with Minimal Stress technology for consistent phaco tip elongation regardless of cataract grade and multiple proven U/S power emission protocols through a wide portfolio of proprietary phaco tip and 40 KHz phaco hand-piece. For vitreoretinal application, it offers a wide range of single-use devices to support 23G and 27G procedures and built in LED Lighting System with 2 independent LED light sources with selectable colour filters for enhanced visualization, free of harmful UV and IR emissions.

User Interface: High visibility 15" touch screen advanced foot-pedal programmable as single or dual linear.



Equipment for Cataract/Vitreoretinal Surgery

Description	SKU #
R-Evo Smart® CR	121013

Equipment for Cataract Surgery

Description	SKU #
R-Evo Smart® E (Flow-based pump only)	111009
R-Evo Smart® S (Flow and vacuum based pumps and venturi pumps)	111010

Cryo-line

Cryo-line is a fully pneumatic system for ophthalmic cryo-surgery employing CO₂ or N₂O as cryogenic gases. It is available for retina and eye-adnexa applications with a complete set of reusable cryo-probes. The system features application time, cylinder adapters, gas filter cartridges and temperature control for precise treatment.



Equipment for Ophthalmic Cryo-surgery

Description	SKU #
Cryo-line	131002

Accessories for Cataract and Cataract/Vitreoretinal Equipment

Foot-pedals



Description	SKU #
Foot-pedal, wireless dual/single linear, R-Evolution® and R-Evolution® CR	112104
Foot-pedal, dual/single linear, R-Evo Smart® E, S and CR	112105

Remote Control for R-Evolution® and R-Evolution® CR



Qty: 1/Bx

Description	SKU #
Remote control for R-Evolution® and R-Evolution® CR	122007

Phaco Hand-piece



113101



113107

Qty: 1/Bx

Description	SKU #
Phaco hand-piece - Slim 4	113101
Phaco hand-piece - Six	113107

Cart



Qty: 1/Bx

Description	SKU #
Cart with integrated IV pole for R-Evo Smart® E, S and CR	181006

Sterilization Tray

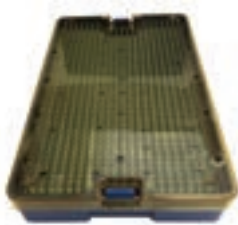

Qty: 1/Bx

Description	SKU #
Sterilization tray 25 x 15 x 3.8 cm for phaco and I/A hand-pieces	116003

Irrigating Solution Continuity Guard



Qty: 1/Bx

Description	SKU #
Irrigating solution continuity guard	181007

Accessories for Cataract and Cataract/Vitreoretinal Equipment

Filters

Qty: 1/Bx

Description	SKU #
Filter, passive protection for ZEISS and Moller microscopes	0MR340833
Filter, passive protection for Leica microscopes	0MR340846
Filter, passive protection for Topcon microscopes	0MR340897
Filter, passive protection for 532 nm wavelength for Topcon microscopes	0MR340990
Filter, active protection for Leica microscopes	0MR340848
Filter, active protection for Zeiss and Moller microscopes	0MR340849
Filter, active protection for Topcon microscopes	0MR340898

Goggles

Qty: 1/Bx

Description	SKU #
Protective goggles, wavelength 532 nm	0MR640425

Accessories for Cryo-surgery Equipment

Cart



Qty: 1/Bx

Description	SKU #
Cart with gas cylinder holder	183001

Cylinder Adapters



132008



132009



132010

Qty: 1/Bx

Description	SKU #
Gas cylinder adapter for nitrous oxide N2O (ISO5145 standard)	132008
Gas cylinder adapter for nitrous oxide (French standard)	132010
Gas cylinder adapter for carbon dioxide (ISO5145 standard)	132009

Cryo Probes for Ophthalmic Cryo-surgery



133002



133004



133005



133006

Qty: 1/Bx

Description	SKU #
Cryo probe for retina, Ball	133002
Cryo probe for retina, "T" shaped	133004
Cryo probe for retina, "Bonnet"	133005
Cryo probe for glaucoma	133006

Procedure Packs

Procedure packs for Cataract Surgery for R-Evolution® and R-Evo Smart®

This configuration supports AGILE™ Fluidics Control (Active fluidics) that minimizes post-occlusion break surge and stabilizes the eye across all steps of the procedure. Moreover, phaco tip pre-assembled with single-use phaco-tip wrench will drive work-flow efficiency.

Fixed Components

Description
EasySys I/A cassette with drainage bag
Drapes (Screen/Mayo Arm)
Air Controlled Irrigation
Administration Set
Test Chamber



Variable Components

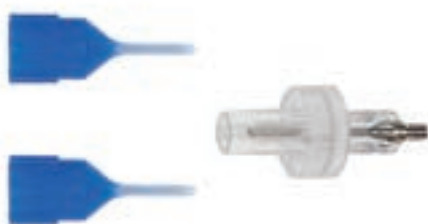

195220

Qty: 10/Bx

Description	Sleeve	Phaco Tip, Assembled on Tip-wrench	SKU #
AGILE™ Phaco Pack 20G F	2x Blue	20G Flared	195220
AGILE™ Phaco Pack 20G FB	2x Blue	20G Flared bent	195320
AGILE™ Phaco Pack 20G S	2x Blue	20G Straight, 30 Degrees	195120
AGILE™ Phaco Pack 21G F	2x Yellow	21G Flared	195221
AGILE™ Phaco Pack 21G FB	2x Yellow	21G Flared bent	195321
AGILE™ Phaco Pack 21G S	2x Yellow	21G Straight, 30 Degrees	195121

S - Straight phaco tip
 F - Flared phaco tip
 FB - Flared-bent phaco tip

More configurations of cataract procedure packs are available upon demand.

Procedure Packs

Procedure Packs for Vitreoretinal Surgery for R-Evolution® CR and R-Evo Smart® CR

Twedge™ VitPack provides the largest portfolio of single-use devices for vitreoretinal procedure, supporting 23G, 25G and 27G pars plana vitrectomy with AGILE™ Fluidics Control and fluid/air exchange set with automatic valve and two-ways stopcock.

Fixed Components

Description
EasySys I/A cassette with drainage bag
Drapes (Screen/Mayo Arm)
Air Controlled Irrigation
Administration Set
Two-ways Stopcock
Fluid/air exchange set with automatic valve



Variable Components



199323

Qty: 5/Bx

Description	Twedge™ High Speed Dual-blade Vitrectomy Probe	Valved Entry System Kit	Endo-illumination Probe	SKU #
23G Twedge™ VitPack SH	✓	23G	Shielded, wide angle	199323
23G Twedge™ VitPack SP	✓	23G	Spot	199123
25G Twedge™ VitPack SH	✓	25G	Shielded, wide angle	199325
25G Twedge™ VitPack SP	✓	25G	Spot	199125
27G Twedge™ VitPack SP	✓	27G	Spot	199127

SP - Spot endo-illumination

SH - Shielded wide angle endo-illumination

More configurations of cataract procedure packs are available upon demand.

*For more Vitreoretinal Pack, please contact your BVI Representative.

Procedure Packs

Procedure Packs for Combined Cataract and Vitreoretinal Surgery for R-Evolution® CR and R-Evo Smart® CR

Fixed Components

Description
EasySys I/A cassette with drainage bag
Drapes (Screen/Mayo Arm)
Air Controlled Irrigation
Administration Set
Two-ways Stopcock
Fluid exchange set with automatic valve
Test Chamber
Twedge™ High Speed Dual-blade Vitrectomy probe
One-step valved entry system kit



Variable Components



199323-20G F

Qty: 5/Bx

Description	Endo-illumination Probe	Sleeve	Phaco Tip, Assembled on Tip-wrench	SKU #
23G Twedge™ UniPack SH 20G F	Shielded, wide angle	2x Blue	Flared	199323-20G F
23G Twedge™ UniPack SP 20G F	Spot	2x Blue	Flared	199123-20G F
23G Twedge™ UniPack SH 20G FB	Shielded, wide angle	2x Blue	Flared-bent	199323-20G FB
23G Twedge™ UniPack SP 20G FB	Spot	2x Blue	Flared-bent	199123-20G FB
23G Twedge™ UniPack SH 21G F	Shielded, wide angle	2x Yellow	Flared	199323-21G F
23G Twedge™ UniPack SP 21G F	Spot	2x Yellow	Flared	199123-21G F
23G Twedge™ UniPack SH 21G FB	Shielded, wide angle	2x Yellow	Flared-bent	199323-21G FB
23G Twedge™ UniPack SP 21G FB	Spot	2x Yellow	Flared-bent	199123-21G FB

S - Straight phaco tip

SP - Spot endo-illumination

F - Flared phaco tip

SH - Shielded wide angle endo-illumination

FB - Flared-bent phaco tip

More configurations of cataract procedure packs are available upon demand.

Procedure Packs

Basic Procedure Packs

Qty: 10/Bx

Description	SKU #
EasySys Irrigation/aspiration kit for R-Evolution® and R-Evo Smart®	192704
EasySys Irrigation/aspiration kit for Assistant/Pulsar II - ESP	192703
Irrigation/aspiration kit for Pulsar II Minimal Stress: Cassette, drainage bag and tubing	191703
Irrigation/aspiration kit for Pulsar II Minimal Stress: Cassette with drainage bag	191704
Irrigation/aspiration kit for Pulsar with tubings, ACS3 device and drainage bag	191702



192704

Other Devices for Irrigation/Aspiration for Cataract and Vitreoretinal Surgery

Air Controlled Irrigation Device



Qty: 5/Bx

Description	SKU #
Air controlled irrigation device	190700

Screen Cover and Mayo Drape for R-Evo Smart®



Qty: 10/Bx

Description	SKU #
Screen cover and Mayo drape for R-Evo Smart®	191616

Kawano Irrigation Surge Suppressor



Qty: 20/Bx

Description	SKU #
Kawano irrigation surge suppressor	191004

Stand Alone Devices and Kits

Anterior Vitrectomy Probe



Qty: 5/Bx

Description	SKU #
Anterior vitrectomy probe with coaxial irrigation	192304

Single Blade Vitreous Cutter



192303

Qty: 5/Bx

Description	SKU #
23G Vitreous cutter single blade	192303
25G Vitreous cutter single blade	192302

Posterier Vitrectomy Probe

Twedge™ dual blade, high speed vitrectomy probe for 23G, 25G and 27G procedures, provide uninterrupted flow for vitreous removal at any cutting rate with minimal tractions to retinal tissues.



192315

Qty: 5/Bx

Description	SKU #
23G Twedge™ dual blade vitreous cutter	192313
25G Twedge™ dual blade vitreous cutter	192315
27G Twedge™ dual blade vitreous cutter	192317

Valved Trocar Kit

This is a kit of valved entry-system build on trocar blade, for implantation assisted by a scleral marker.



192223

Qty: 10Bx

Description	SKU #
23G Valved trocar kit	192223
25G Valved trocar kit	192225
27G Valved trocar kit	192227

Endo Illumination Probes for Vitreoretinal Surgery



192808

Qty: 5/Bx

Description	SKU #
23G Shielded wide angle probe	192816
25G Shielded wide angle probe	192845
23G Standard probe	192807
25G Standard probe	192808
27G Standard probe	192818
25G Chandelier with adjustable ring	192817

Endo Diathermy Probes



192623

Qty: 5/Bx

Description	SKU #
23G Endo Diathermy probe	192623
25G Endo Diathermy probe	192625
27G Endo Diathermy probe	192627

Stand Alone Devices and Kits

Endo Laser Probes for Vitreoretinal Surgery

Qty: 5/Bx

Description	SKU #
23G Endo laser, Straight, Blue	OAK-0431/SMH
23G Endo laser, Angled, Blue	OAK-0435/SMH
25G Endo laser, Straight, Orange	OAK-0432/SMH
25G Endo laser, Angled, Orange	OAK-0436/SMH
27G Endo laser, Straight, Magenta	OAK-0433/SMH
27G Endo laser, Angled, Magenta	OAK-0437/SMH

Viscous Fluid Removal Kit



Qty: 10/Bx

Description	SKU #
Viscous fluid removal kit with 19G cannula,	192525

Silicone Oil Injection/Removal Kit



Qty: 1/Bx

Description	SKU #
Injection/removal silicone oil kit with 20G/23G/25G cannulas, single use (5 pcs)	192540

Automatic Balanced Saline Solution/Air Infusion Control System



Qty: 5/Bx

Description	SKU #
Automatic balanced saline solution/Air infusion control system	192550

Air Injection Tube with Filter



Qty: 5/Bx

Description	SKU #
Air injection tube with filter	192513

Adapter Syringe Tubing



192516

Qty: 10/Bx

Description	SKU #
Adapter syringe tubing LLF	192519
Adapter for simultaneous connection Air/minimal IOP	192516
Adapter syringe tubing LLF-Assistant/Pulsar II - ESP	192518

Stand Alone Devices and Kits

Two-ways Stopcock



Qty: 10/Bx

Description	SKU #
Two-ways stopcock	192514

Backflush Handles



Qty: 5/Bx

Description	SKU #
Backflush handpiece, Active/passive	192110

Tips for Vitreoretinal Surgery



192123

Qty: 5/Bx

Description	SKU #
23G Soft tip cannula	192123
23G Blunt tip cannula	192133
25G Soft tip cannula	192125
25G Blunt tip cannula	192135
27G Soft tip cannula	192127
27G Blunt tip cannula	192137

Reusable Devices for Surgical Equipment

Cassette, I/A Tubing, Drainage Bag and Other Accessories



Qty: Varies/Bx

Description	SKU #
EasySys reusable I/A cassette for R-Evo Smart®, Qty: 2	117006
EasySys reusable cassette, drainage bag for R-Evo Smart®, Qty: 10	116002
EasySys reusable cassette, cassette-wrench for R-Evo Smart®, Qty: 1	116008
Irrigation/aspiration tubing set with ACS3 device for Pulsar, Qty: 1	117001
Irrigation/aspiration tubing set for Pulsar II Minimal Stress, Qty: 1	117004

Phaco Tips



Qty: 1/Bx

Description	SKU #
20G Flared phaco tip, 30 Degrees, Blue	113240
20G Flared bent phaco tip, 30 Degrees, Blue	113250
20G Standard phaco tip, 30 Degrees, Blue	113206
21G Flared phaco tip, 30 Degrees, Yellow	113241
21G Flared bent phaco tip, 30 Degrees, Yellow	113251
21G Standard phaco tip, 30 Degrees, Yellow	113237
22G Flared phaco tip, 30 Degrees, Green	113242
22G Standard phaco tip, 30 Degrees, Green	113209
Pars plana phaco tip	113217

Phaco Tip Wrench

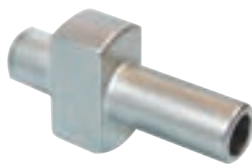

Qty: 1/Bx

Description	SKU #
Phaco tip wrench	113402

Silicone Sleeves



Qty: 3/Bx

Description	SKU #
Silicone sleeve for 20G tips - (2.8 mm incision), Blue	113308
Silicone sleeve for 21G tips - (2.3 mm incision), Yellow	113307
Silicone sleeve for 22G tips - (1.8 mm incision), Green	113309

Reusable Devices for Surgical Equipment

Irrigation/Aspiration Hand-piece for Cataract Surgery



Qty: 1/Bx

Description	SKU #
Coaxial I/A hand-piece, Long barrel	114101

Irrigation/Aspiration Cannulas for Cataract Surgery



Qty: 1/Bx

Description	SKU #
20G Straight I/A cannula with silicone sleeve, Blue	114216
20G Angled I/A cannula with silicone sleeve, Blue	114217
21G Straight I/A cannula with silicone sleeve, Yellow	114218
21G Angled I/A cannula with silicone sleeve, Yellow	114219
22G Straight I/A cannula with silicone sleeve, Green	114222
22G Angled I/A cannula with silicone sleeve, Green	114223

Handpieces



114301



114302

Qty: 1/Bx

Description	SKU #
Bimanual I/A, Irrigation cannula	114301
Bimanual I/A, Aspiration cannula	114302

Eso-diathermy

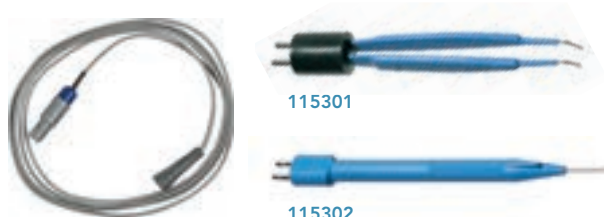

115001

115301

115302

Qty: 1/Bx

Description	SKU #
Diathermy bipolar cable	115101
Diathermy forceps	115301
Diathermy pencil eraser	115302

Dual Luer Connector

Qty: 1/Bx

Description	SKU #
Dual Luer Connector for PULSAR Vit Module	811011000

Diagnostic Equipment and Accessories for Corneal Topography

Keratron™ Scout

This corneal topographer is aimed at those users who want a compact and portable instrument.



Qty: 1/Bx

Description	SKU #
Keratron™ Scout	161204

Keratron™ Piccolo

The Keratron™ Piccolo combines excellent performance with portability and maneuverability.



Qty: 1/Bx

Description	SKU #
Keratron™ Piccolo	161301

Keratron™ Nova

The most recent evolution of the family of Keratron topographers, Keratron™ Nova represents a standard of excellence in corneal topography. The only portable topographer, able to capture and process images, process maps on board and which has an internal patient database exportable via LAN or USB.



Qty: 1/Bx

Description	SKU #
Keratron™ Nova	161601

Diagnostic Equipment and Accessories for Corneal Topography

Docking Base for Keratron™ Scout



Qty: 1/Bx

Description	SKU #
Docking base for Keratron™ Scout	162202

Slit Lamp Adaptor Kit for Keratron™ Scout



Qty: 1/Bx

Description	SKU #
Slit lamp adaptor kit for Keratron™ Scout	162206

Far Mire Cone for Keratron™ Scout/Keratron™ Piccolo



Qty: 1/Bx

Description	SKU #
Far mire cone for Keratron™ Scout/Keratron™ Piccolo	162211

Base with Joystick for Keratron™ Piccolo



Qty: 1/Bx

Description	SKU #
Base with joystick for Keratron™ Piccolo	163202

Docking Base for Keratron™ Scout



Qty: 1/Bx

Description	SKU #
Base with joystick for Keratron™ Nova	163204

Accessories for Ultrasound Diagnostics

Reusable Probes and Accessories



153005

Qty: 1/Bx

Description	SKU #
8 MHz Diagnostic A-Scan probe	143011
10 MHz Biometry probe	143001
50 MHz Straight pachymetry probe	153005
12 MHz B-Scan probe	143200
20 MHz B-Scan probe	143300
50 MHz B-Scan probe	143500
35 MHz B-Scan probe	143600

Connecting Cable



Qty: 1/Bx

Description	SKU #
Connecting cable for B-Scan probe	143016

Cups for Immersion Biometry



149009

Qty: 1/Bx

Description	SKU #
Cup for immersion biometry Ø 14 mm	149006
Cup for immersion biometry Ø 18 mm	149008
B-Scan cups kit for immersion 19/22/24 mm	149009

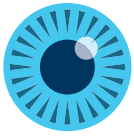

BVI

Addressing Control of Light Beam Direction

29G Spotlight Directional Chandelier

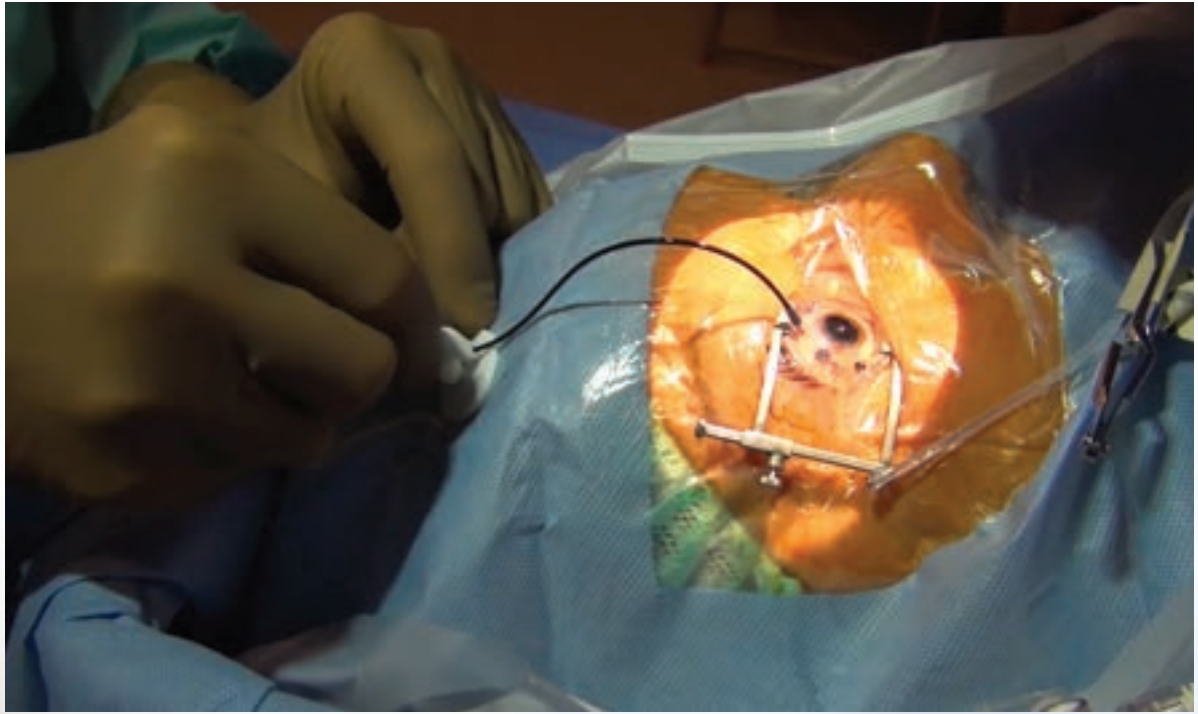

Enabling Bimanual Surgery With:

- Directional control of light-beam for enhanced visualization
- 29G valved entry system for straightforward light fiber entrance, fixation and removal
- Stationary and wide field endo-illumination

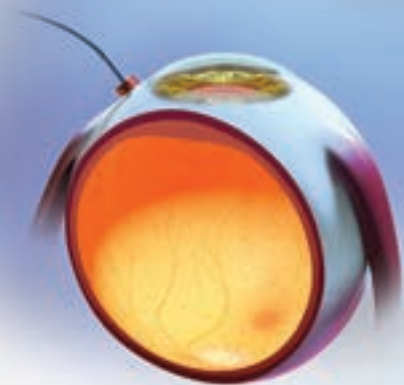

Patent Pending

Vitreco

Vitreoretinal Surgical Products

bvimedical.com

29G Spotlight Directional Chandelier

29G Spotlight Directional Chandelier

Sets new standards in light beam direction control, it delivers stationary, diffuse wide-field endo-illumination enabling bimanual surgery.



Qty: 5/Bx
Brand: Vitreq®

Description	SKU #
29G Spotlight Directional Chandelier, Sterile	LF29.D02

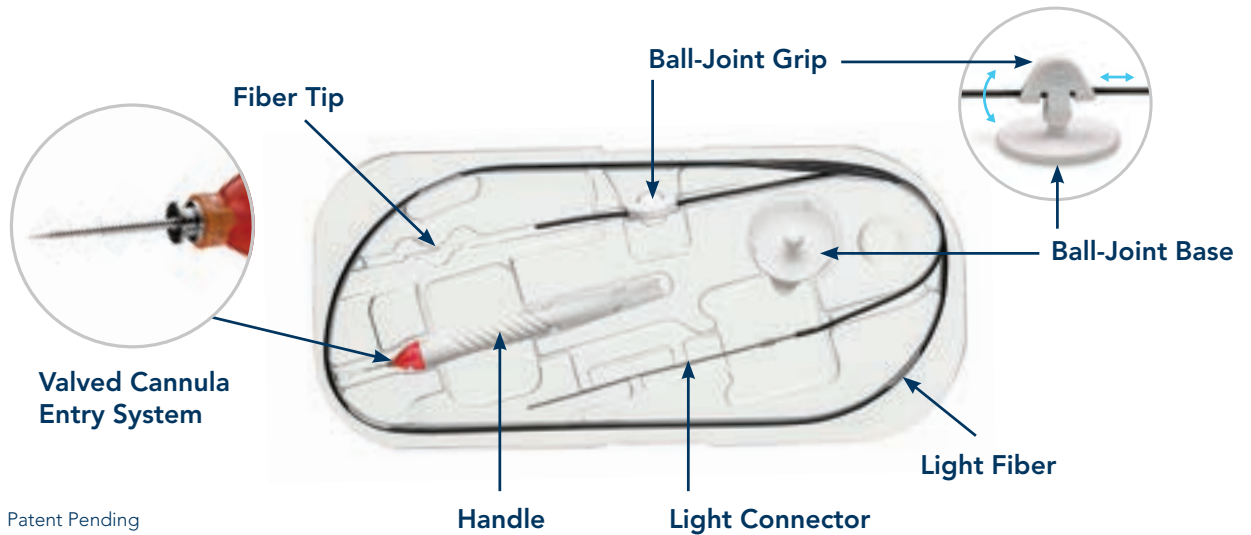



Improved Intraocular Surgical Control and Precision in Surgical Maneuvers

Micro Forceps and Scissors



Tip Design

- Shortened tip provides stronger grasping force¹

Shaft Design

- Rigid shaft designed to reduce flexibility for better control
- 25% less flexible than competitors while maintaining 32 mm working shaft length¹

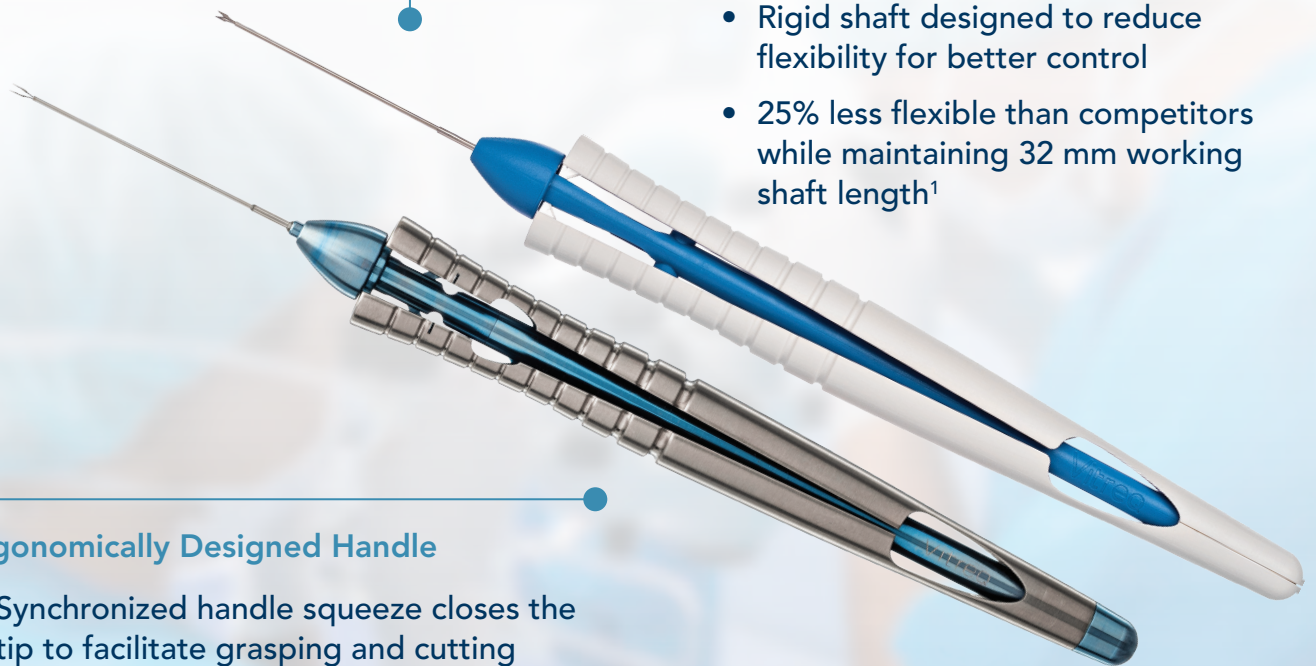

Ergonomically Designed Handle

- Synchronized handle squeeze closes the tip to facilitate grasping and cutting
- Round handle allows for tip alignment

¹ Data on file

Micro Forceps

Gauge Size with Color Coding

Single-Use All Single-Use Sold in 5/Bx

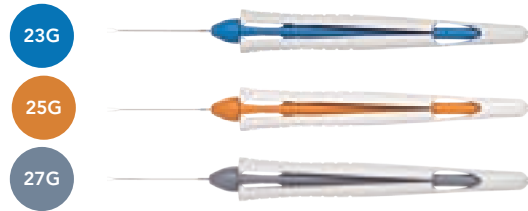

Reusable All Reusable Sold in 1/Bx

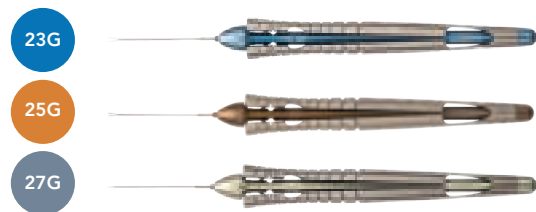

Serrated Gripping

Serrated Gripping Micro Forceps are designed for grasping strong adherent PVR membranes.

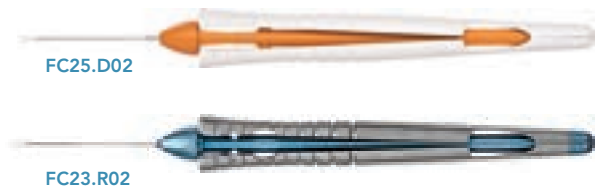

Brand: Vitreq®

Description	SKU #
● 23G Single-Use	FC23.D02
● 25G Single-Use	FC25.D02
● 23G Reusable	FC23.R02
● 25G Reusable	FC25.R02

ILM End-gripping

ILM end-gripping forceps have thin tips for ILM and ERM peeling. Designed to improve visualization for grasping thin membranes.



Brand: Vitreq®

Description	SKU #
● 23G Single-Use	FC23.D03
● 25G Single-Use	FC25.D03
● 27G Single-Use	FC27.D03
● 23G Reusable	FC23.R03
● 25G Reusable	FC25.R03
● 27G Reusable	FC27.R03

Asymmetrical Gripping

Asymmetrical tips allow visualization at grasping area and interior end-gripping platforms are designed for assured grasping. The tip design targets ILM, fine epiretinal membranes and diabetic PVR membranes.



Brand: Vitreq®

Description	SKU #
● 23G Single-Use	FC23.D04
● 25G Single-Use	FC25.D04
● 23G Reusable	FC23.R04
● 25G Reusable	FC25.R04

Micro Forceps

Eckardt Endgripping

Eckardt forceps with wider tip are designed to enhance surface grasping and reduce tearing effect. Shorter tip branches designed to enhance grasping and holding power. Designed for ILM, ERM peeling and general peeling of fine membranes which needs end-gripping action.

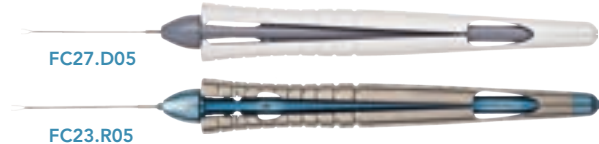

Brand: Vitreq®

Description	SKU #
● 23G Single-Use	FC23.D05
● 25G Single-Use	FC25.D05
● 27G Single-Use	FC27.D05
● 23G Reusable	FC23.R05
● 25G Reusable	FC25.R05
● 27G Reusable	FC27.R05

Shah X-tra Grip*

Fine tipped forceps with serrated jaws platform for maximum grasping of the tissue. Effective for all types of tissue manipulation, ILM, ERM, PVR and diabetic tissue.



Brand: Vitreq®

Description	SKU #
● 23G Single-Use	FC23.D07
● 25G Single-Use	FC25.D07
● 27G Single-Use	FC27.D07
● 23G Reusable	FC23.R07
● 25G Reusable	FC25.R07
● 27G Reusable	FC27.R07

Kuhn 45° Power Gripping*

Kuhn 45 Degree Power Gripping forceps are designed for peeling proliferative intravitreal, epi and sub-retinal membranes, lens capsule, iris, small IOFB, fibrinous membranes, as well as ILM and ERM membranes and posterior hyaloids. With a 45 degree crocodile designed inner surface, these instruments are designed to enable selective, strong grasping, and visibility of the target tissue.



Brand: Vitreq®

Description	SKU #
● 23G Single-Use	FC23.D06
● 25G Single-Use	FC25.D06
● 23G Reusable	FC23.R06
● 25G Reusable	FC25.R06

Micro Scissors

Vertical

Sharp-tipped vertical cutting scissors for cutting perpendicular to the retina.



Brand: Vitreq®

Description	SKU #
● 23G Single-Use	SC23.D01
● 25G Single-Use	SC25.D01
● 27G Single-Use	SC27.D01
● 23G Reusable	SC23.R01
● 25G Reusable	SC25.R01

Straight

Sharp-tipped straight cutting scissors for cutting in the iris plane and cutting peripheral membranes.



Brand: Vitreq®

Description	SKU #
● 23G Single-Use	SC23.D02
● 25G Single-Use	SC25.D02
● 23G Reusable	SC23.R02
● 25G Reusable	SC25.R02

Horizontal Curved

Sharp-tipped horizontal curved cutting scissors for cutting membranes adherent to the retinal surface. The tip's curvature of 12mm follows the contour of the retina.

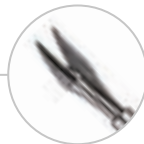

Brand: Vitreq®

Description	SKU #
● 23G Single-Use	SC23.D03
● 25G Single-Use	SC25.D03
● 27G Single-Use	SC27.D03
● 23G Reusable	SC23.R03
● 25G Reusable	SC25.R03
● 27G Reusable	SC27.R03

Reusable Cleaning Adapter

Unique cleaning/sterilization adapter included with every reusable instrument option.



Qty: 1/Bx
Brand: Vitreq®

Description	SKU #
Reusable Cleaning Adapter	FC00.R03

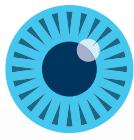

BVI

90° Directional Laser Probes

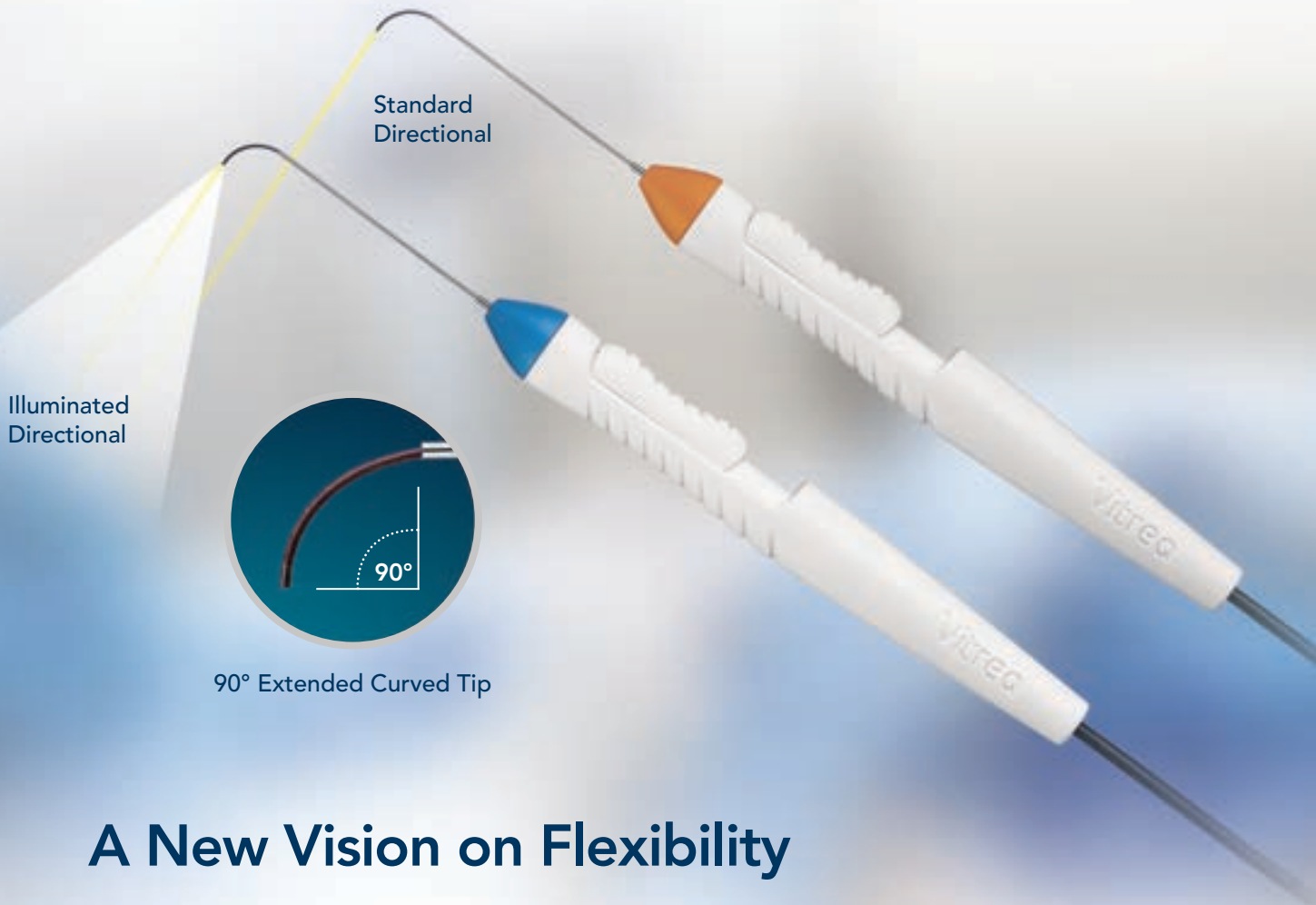

A New Vision on Flexibility

- 90° curved extendable tip for access to peripheral retina
- Hardened metal shaft reduces flexibility by 25%¹
- Retractable mechanism designed to improve control of instrument tip and reduce risk of accidental removal of cannula
- Available in standard (23G, 25G and 27G) and illuminated (23G and 25G) color coded for easy gauge identification
- Compatible with all major equipment

¹ Data on file

Vitreco

Vitreoretinal Surgical Products

Vitreoretinal Surgical Products

90° Directional Laser Probes Designed For Improved Surgical Control. The ergonomic handle was designed for improved intraocular surgical control and the sliding knob to control the motion of the instrument tip.

Standard Directional*

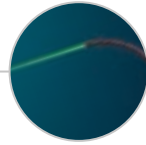

Qty: 1/Bx
Brand: Vitreq®

Description	SKU #
● 23G Compatible with Alcon®	LP23.A04
● 23G Compatible with DORC®	LP23.D04
● 23G Compatible with Iridex® and B&L	LP23.I04
● 25G Compatible with Alcon®	LP25.A04
● 25G Compatible with DORC®	LP25.D04
● 25G Compatible with Iridex® and B&L	LP25.I04
● 27G Compatible with Alcon®	LP27.A04
● 27G Compatible with DORC®	LP27.D04
● 27G Compatible with Iridex® and B&L	LP27.I04

Illuminated Directional*



Qty: 1/Bx
Brand: Vitreq®

Description	SKU #
● 23G Compatible with Alcon®	LP23.A05
● 23G Compatible with DORC®	LP23.D05
● 23G Compatible with Iridex® and B&L	LP23.I05
● 25G Compatible with Alcon®	LP25.A05
● 25G Compatible with DORC®	LP25.D05
● 25G Compatible with Iridex® and B&L	LP25.I05

* All product names, trademarks and registered trademarks are property of their respective owners.

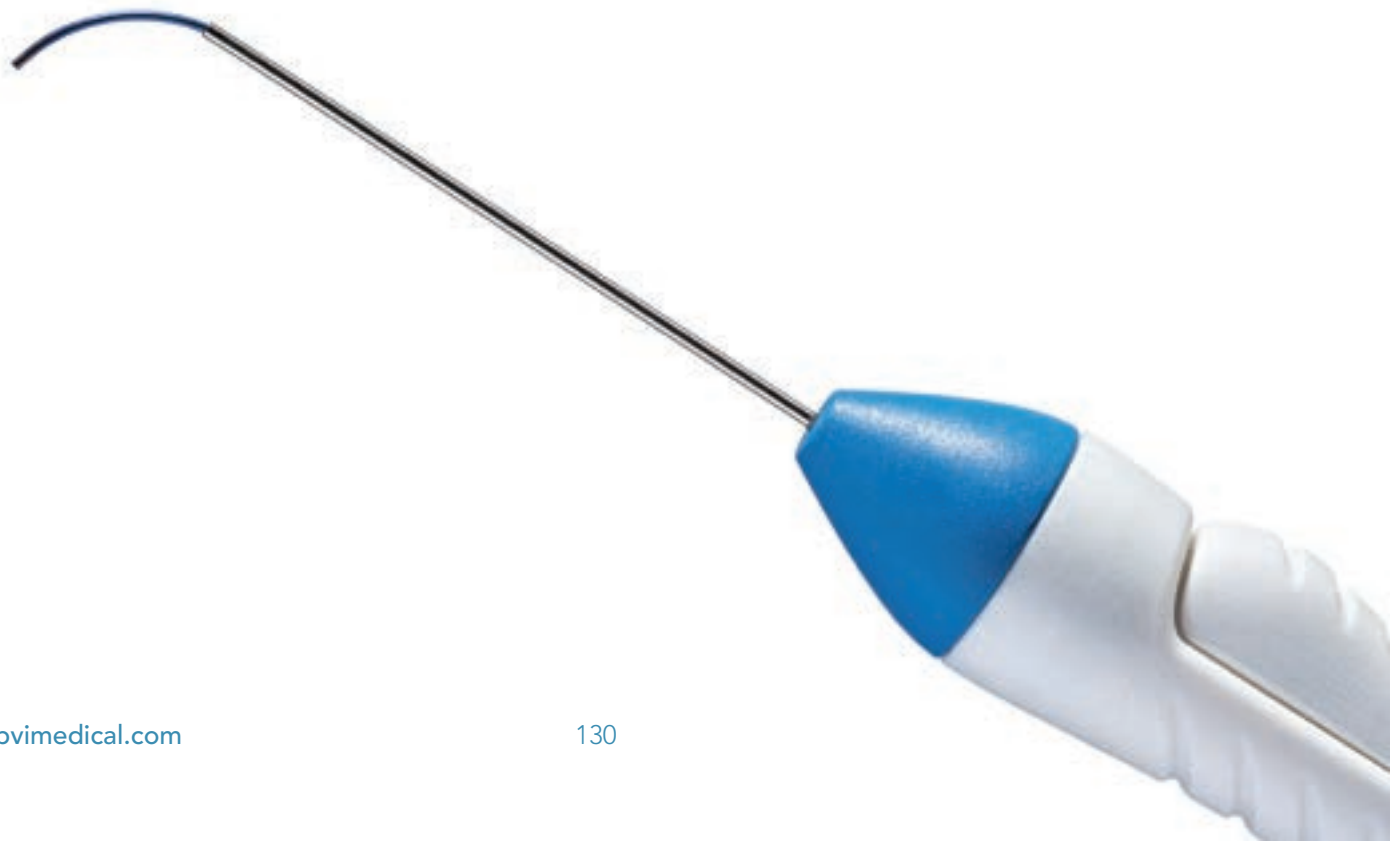

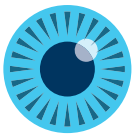

BVI

Backflush Instruments

Atraumatic Aspiration and Brushing Procedures
Thanks to Improved Intraocular Surgical Control

- Passive and active aspiration control in one instrument
- High volume backflush reservoir for increased capacity during vitreoretinal surgery
- Long shaft (33 mm) makes them suitable for myopic eyes
- Blunt tip and silicone brush needles for atraumatic aspiration and brushing of retinal surface



Vitreco

Vitreoretinal Surgical Products

bvimedical.com

Disposable Backflush Instruments

Disposable backflush instruments are available in three different styles.

Standard

Blunt or brush tip



Blunt tip



Brush tip



23G Backflush Instruments Brush
BF23.D02

Retractable

Silicone brush retracts into the instrument shaft for smooth and valved cannula entry



23G Retractable Brush
BF23.D05

Extendable

8 mm extendable silicone tip for draining fluid from behind retina and other standard backflush procedures



23G Backflush Instruments Extendable Silicone Tip
BF23.D07

Disposable backflush instruments are shipped with cap and tubing for passive or active use during procedures. The direct connection between reservoir and needle allows no contact between hand piece and intraocular fluids.

Backflush Options

All single-use products are provided Sterile and Ready-for-Use.

Standard



Qty: 5/Bx
Brand: Vitreq®

BF23.D02

Description	SKU #
● 23G Blunt backflush instrument	BF23.D01
● 23G Brush backflush instrument	BF23.D02
● 25G Blunt backflush instrument	BF25.D01
● 25G Brush backflush instrument	BF25.D02
● 27G Blunt backflush instrument	BF27.D01
● 27G Brush backflush instrument	BF27.D02

Retractable



Qty: 5/Bx
Brand: Vitreq®

BF23.D05

Description	SKU #
● 23G Retractable brush BF-instrument	BF23.D05
● 25G Retractable brush BF-instrument	BF25.D05

Extendable



Qty: 5/Bx
Brand: Vitreq®

BF23.D07

Description	SKU #
● 23G Extendable silicone tipped BF-instrument	BF23.D07
● 25G Extendable silicone tipped BF-instrument	BF25.D07



Reusable Backflush Instruments

Featuring an ergonomically designed handle, rigid shaft and high volume backflush reservoir for increased backflush capacity, with Passive and Active Aspiration.

Universal Backflush Instrument



Qty: 1/Bx
Brand: Vitreq®

Description	SKU #
Universal Backflush Instrument	BF00.R01

Backflush Instrument with Luer-lock Connector



Qty: 1/Bx
Brand: Vitreq®

Description	SKU #
Universal Backflush Instrument	BF00.R02

Backflush Consumables

Disposable Universal Backflush Needles

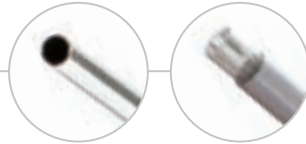

BF23.D51

Qty: 5/Bx
Brand: Vitreq®

Description	SKU #
● 23G BF Blunt needles	BF23.D51
● 23G BF Brush needles	BF23.D52
● 25G BF Blunt needles	BF25.D51
● 25G BF Brush needles	BF25.D52

Blunt Needles with Luer-Lock

Stainless steel cannula with blunt tip for aspiration or injection with syringe or tubing.

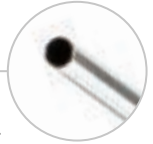

CN23.D05

Qty: 5/Bx
Brand: Vitreq®

Description	SKU #
● 23G Blunt needle with luer-lock connector	CN23.D05
● 25G Blunt needle with luer-lock connector	CN25.D05
● 27G Blunt needle with luer-lock connector	CN27.D05

Backflush Reservoirs



Passive Reservoir
BF00.D51



Active Reservoir
BF00.D52

Qty: 5/Bx
Brand: Vitreq®

Description	SKU #
Backflush reservoirs, Passive	BF00.D51
Backflush reservoirs, Active	BF00.D52

Disposable Tubing for Active Aspiration



Qty: 5/Bx
Brand: Vitreq®

Description	SKU #
Disposable tubing for active aspiration	BF00.D53

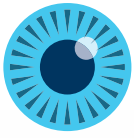

BVI

Light Fibers

A Bright Vision on Illumination



Standard
Light Fibers



Wide View
Light Fibers



45 Degree Shielded
Light Fibers

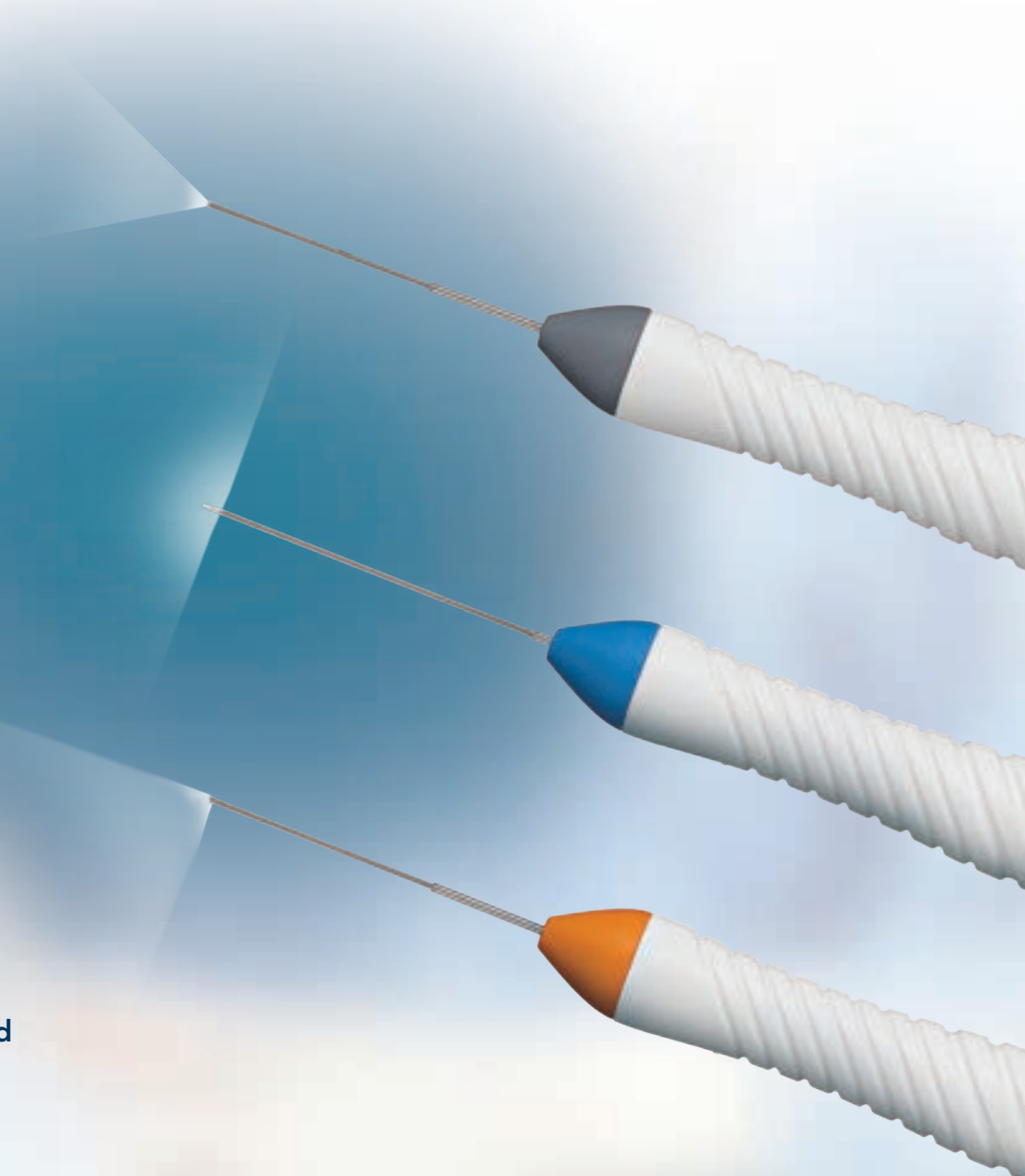

Vitreco

Vitreoretinal Surgical Products

bvimedical.com

Light Fibers

Light Fibers featuring high-end specifications with consistent quality performance for ophthalmic endo-illumination procedures.

Standard Light Fibers



LF23.D01

Qty: 5/Bx
Brand: Vitreq®

Description	SKU #
● 23G Standard light fibers	LF23.D01
● 25G Standard light fibers	LF25.D01
● 27G Standard light fibers	LF27.D01

45 Degree Shielded Light Fibers



LF27.D03

Qty: 5/Bx
Brand: Vitreq®

Description	SKU #
● 23G 45 Degree shielded light fibers	LF23.D03
● 25G 45 Degree shielded light fibers	LF25.D03
● 27G 45 Degree shielded light fibers	LF27.D03

Wide View Light Fibers



LF25.D02

Qty: 5/Bx
Brand: Vitreq®

Description	SKU #
● 23G Wide view light fibers	LF23.D02
● 25G Wide view light fibers	LF25.D02
● 27G Wide view light fibers	LF27.D02

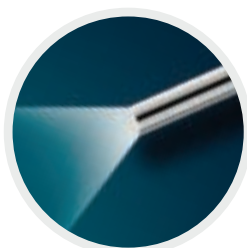

Standard Light Fibers

Straight tip for focal endo-illumination.

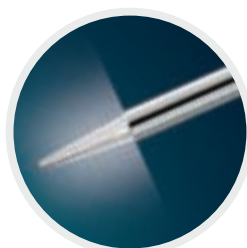

Wide View Light Fibers

Wide view tip for global endo-illumination.

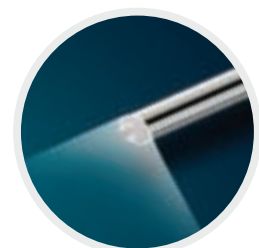

45 Degree Shielded Light Fibers

45 Degree shielded wide view tip for shielded endo-illumination.



Vitreoretinal Consumables



Vitreco
Vitreoretinal Surgical Products

Disposable Vitrectomy Lenses

Comprised of optically crystal-clear PMMA, vitrectomy lenses have a high refraction index creating excellent intraocular visualization. A highly stable position on the eye can be achieved thanks to a flexible TPE ring, molded with four haptics. A complete range of lenses providing specific enhanced visualization in the posterior of the eye.

Flat Style

FOV of the central posterior pole and vitreous in phakic and pseudophakic eyes



Qty: 5/Bx
Brand: Vitreq®

Description	SKU #
Vitrectomy lens flat style	VL00.D01

Wide Field Style

FOV when visualizing central posterior pole and central vitreous in phakic and pseudophakic eyes



Qty: 5/Bx
Brand: Vitreq®

Description	SKU #
Vitrectomy lens wide view style	VL00.D04

Biconcave Style

View of fundus in air-filled vitreous cavity in phakic and pseudophakic eyes



Qty: 5/Bx
Brand: Vitreq®

Description	SKU #
Vitrectomy lens biconcave style	VL00.D02

30° Prism Style

View of posterior peripheral fundus/vitreous beyond equator in phakic, aphakic and pseudophakic eyes



Qty: 5/Bx
Brand: Vitreq®

Description	SKU #
Vitrectomy lens 30° prism style	VL00.D05

Magnifying Style

For detailed examination of intricate manipulation of retinal membranes in phakic and pseudo-phakic eyes



Qty: 5/Bx
Brand: Vitreq®

Description	SKU #
Vitrectomy lens magnifying style	VL00.D03

Vitreoretinal Cannulas and Needles

New disposable vitreoretinal cannulas and needles include innovative design features to optimize difficult surgical maneuvers. The products are designed to allow the VR surgeon control over some of the most challenging VR procedures. For example, the range includes PFC needles that facilitate injection with minimized pressing force and have a central bore that enables a high volume of heavy liquids to enter the eye at a minimal velocity.

VFI Cannula

Silicone oil injection and removal through entry system. High flow rates due to thin walls. Can be directly connected to the silicone oil syringe or to aspiration device.



CN23.D03

Qty: 5/Bx
Brand: Vitreq®

Description	SKU #
● 23G VFI cannula	CN23.D03
● 25G VFI cannula	CN25.D03
● 27G VFI cannula	CN27.D03

Silicone Tip Cannula

Stainless steel cannula with 2 mm silicone tip for aspiration and manipulation.



CN25.D01

Qty: 5/Bx
Brand: Vitreq®

Description	SKU #
● 23G Silicone tipped cannula	CN23.D01
● 25G Silicone tipped cannula	CN25.D01

Subretinal Fluid Cannula (Grizzard)

Straight. Sleeve extends 6 mm beyond end.



585021

Qty: 5/Bx
Brand: Visitec®

Description	SKU #
● 20G, 0.9 mm	585021

High Viscosity Injector (Hammer)

Thinwall cannula.



585173

Qty: 5/Bx
Brand: Visitec®

Description	SKU #
● 20G (0.9 mm), 4 mm, 10 cm Tube	585173
● 20G (0.9 mm), 4 mm, 16 cm Tube	585208

Vitreoretinal Cannula

Attaches to handpiece or syringe with luer fitting. Can also be used to aspirate or inject silicone oil.



585205

Qty: 10/Bx
Brand: Visitec®

Description	SKU #
● 20G x 1-1/8 in, 0.9 x 28 mm	585205

Soft Tip Cannula

Soft Tip cannulas have flexible, high-flow silicone tips, allowing gentle access to the retina. They are ideal for aspiration of fluid from on or beneath the surface of the retina.



587002

Qty: 10/Bx
Brand: Visitec®

Description	SKU #
● 23G x 1-1/3 in, 0.6 x 33 mm, 0.3 mm tip	585226
● 25G x 1-1/3 in, 0.5 x 33 mm, 0.3 mm tip	585229
● 23G x 1-1/3 in, 0.6 x 33 mm, 0.8 mm tip	587002
● 25G x 1-1/3 in, 0.5 x 33 mm, 0.8 mm tip	587003

Vitreoretinal Cannulas and Needles

PFC* Injection Needles

New, optimized, PFC injection needle facilitates injection with minimized pressing force. The central bore permits a high volume of heavy liquid to enter the eye at a minimal velocity under controlled conditions.



MD23.D01

Qty: 5/Bx
Brand: Vitreq®

Description	SKU #
● 23G PFC injection needle	MD23.D01
● 25G PFC injection needle	MD25.D01

* Perfluorocarbon

Pick Needles

Stainless steel cannula with pick tip. Can be connected to a syringe or other handpiece.



CN25.D04

Qty: 5/Bx
Brand: Vitreq®

Description	SKU #
● 23G Pick needle	CN23.D04
● 25G Pick needle	CN25.D04

Disposable Universal Backflush Needles

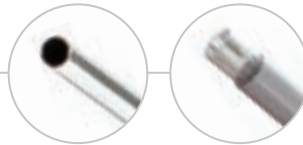

BF23.D51

Qty: 5/Bx
Brand: Vitreq®

Description	SKU #
● 23G BF Blunt needles	BF23.D51
● 23G BF Brush needles	BF23.D52
● 25G BF Blunt needles	BF25.D51
● 25G BF Brush needles	BF25.D52

Blunt Needles with Luer-Lock

Stainless steel cannula with blunt tip for aspiration or injection with syringe or tubing.



CN23.D05

Qty: 5/Bx
Brand: Vitreq®

Description	SKU #
● 23G Blunt needle with luer-lock connector	CN23.D05
● 25G Blunt needle with luer-lock connector	CN25.D05
● 27G Blunt needle with luer-lock connector	CN27.D05

Retractable Tissue Manipulators

FEATURES

- Retractable silicone tip with special ribbed structure
- The green colored silicone tip allows for a clear differentiation to the red retinal surface

Tips

Available in 23G and 25G. Disposable and ready to use.



TM23.D01

Qty: 5/Bx
Brand: Vitreq®

Description	SKU #
● 23G Retractable tissue manipulator	TM23.D01
● 25G Retractable tissue manipulator	TM25.D01

Light Source Adaptors

The Light Fibers are compatible with most endo-illumination systems in combination with Light Source Adaptors*.

Constellation® Light Source Adaptor



Qty: 1/Bx
Brand: Vitreq®

Description	SKU #
Constellation® Light Source Adaptor	LF00.R01

Ruck® Light Source Adaptor

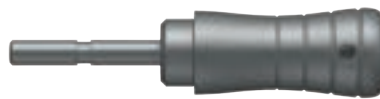

Qty: 1/Bx
Brand: Vitreq®

Description	SKU #
Ruck® Light Source Adaptor	LF00.R04

Stellaris® Light Source Adaptor



Qty: 1/Bx
Brand: Vitreq®

Description	SKU #
Stellaris® Light Source Adaptor	LF00.R02

DORC® Light Source Adaptor



Qty: 1/Bx
Brand: Vitreq®

Description	SKU #
DORC® Light Source Adaptor	LF00.R05

Geuder® Light Source Adaptor



Qty: 1/Bx
Brand: Vitreq®

Description	SKU #
Geuder® Light Source Adaptor	LF00.R03

Accessories

Williamson Scleral Depressor

The Williamson scleral depressor is specially designed to be used for VR-surgery in combination with small gauge entry and BIOM® systems. First scleral indenter specially designed to be used in combination with entry systems with particular attention to sizing and angulation of the indenting surfaces.

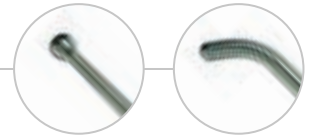

Qty: 1/Bx
Brand: Vitreq®



Description	SKU #
3 mm Ball tip, 45 Degree bent tip	VS00.R02

* All product names, trademarks and registered trademarks are property of their respective owners.

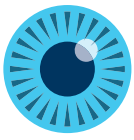

BVI

Liquids and Gases



OVDs

NuVisc™ Pro

The product consists of a highly viscous, cohesive, sterile, viscoelastic, clear, isotonic solution for intraocular use, supplied in a ready-to-use glass syringe with one sterile 25G 7/8 in (0.5 x 22 mm) cannula.

Qty: 1/Bx
Brand: NuVisc™ Pro



Description	SKU #
NuVisc™ PRO Ophthalmic Viscosurgical Device (OVD)	37758
NuVisc™ PRO General Specifications	
Composition	1.6% Sodium Hyaluronate
Dispersity	Viscous cohesive
Volume	1 ml
Source	Biofermentation
Mean Molecular Weight	1.5 Mda
Cannula	25G
Dynamic Viscosity	22,000 mPa·s
Osmolity	285 to 335 mOsm/kg
pH	6.8 - 7.6
Storage Conditions	2°C to 25°C
Shelf Life	Two (2) years from manufacturing date

Saline Solutions

Standard Solutions

Qty: Varies/Bx
Brand: BVI



Description	SKU #
Saline solution, 25 ml plastic bottle, 50/Bx	585831
Saline solution, 500 ml plastic bottle, 12/Bx	581729
Saline solution, 500 ml plastic bottle (double boxed), 12/Bx	581730
Saline solution, 500 ml glass bottle, 12/Bx	581732
Saline solution, 500 ml plastic bag (double boxed), 15/Bx	581738

Enriched Saline Solution

Enriched saline solution contains an antioxidant (Glutathione), a buffer (Sodium Bicarbonate) and an energy source (Glucose). A key purpose of an intraocular irrigation solution is to maintain both the anatomic and physiologic integrity of intraocular tissues. Aqueo Premium provides adequate protection during anterior and posterior segment surgery, due to the chemical composition being similar to the aqueous and vitreous humor.

Qty: 6/Bx
Brand: BVI



Description	SKU #
Aqueo Premium™ 500 ml glass bottle and 25 ml plastic bottle	585833

Surgical Dyes

Monoblue-ILM View

Monoblue-ILM View is an ultra-purified DDG solution presented in a single dose syringe with 0.5ml of 0.025%. DDG Monoblue-ILM View is intended for the staining of the Inner Limiting Membrane (ILM).



Qty: 5/Bx
Brand: ARCADOPHTA

Description	SKU #
Monoblue-ILM, Box of 5 syringes, 0.5 ml	602

Monoblue-Dual View

Monoblue-Dual View is an ultra-purified fixed combination of 2 staining agents Trypan Blue and DDG. Monoblue-Dual View is intended for the staining of the Epiretinal membrane and the internal limiting membrane (ERM/ILM).



Qty: 5/Bx
Brand: ARCADOPHTA

Description	SKU #
Monoblue-Dual, Box of 5 syringes, 0.5 ml	609

Monoblue NafX

Monoblue NafX is a purified Trypan blue high density isotonic sterile and non-pyrogenic solution presented in a single dose syringe with 0.75 ml of 0.15% solution. Providing dying efficiency and visualization of ERM.



Qty: 5/Bx
Brand: ARCADOPHTA

Description	SKU #
Monoblue NafX, Box of 5 syringes, 0.75 ml	615

Monoblue SafR

Monoblue SafR is a purified Trypan blue isotonic sterile solution presented in single dose syringe containing 0.75 ml of 0.055% solution. Intended for temporary staining of the anterior segment.



Qty: 5/Bx
Brand: ARCADOPHTA

Description	SKU #
Monoblue SafR, Box of 5 syringes, 0.75 ml	655

Tamponade Agents

Perfluorocarbon

Arcaline

Arcaline is composed of 100% perfluorodecalin C10F18 - 97% purified. PFCL is used for several indications in vitreoretinal surgery, including drainage of subretinal fluids to favor re-adhesion of detached retina to the underlining tissue.



103

Qty: 1/Bx
Brand: ARCADOPHTA

Description	SKU #
Arcaline 5 ml vial	102
Arcaline 7 ml vial	103
Arcaline 5ml vial - China Market	106

Arcotane

Arcotane is composed of 100% perfluorooctane C8F18 - 99% purified. PFCL is used for several indications in vitreoretinal surgery, including drainage of subretinal fluids to favor re-adhesion of detached retina to the underlining tissue.



104

Qty: 1/Bx
Brand: ARCADOPHTA

Description	SKU #
Arcotane 5 ml vial	104
Arcotane 7 ml vial	105

Tamponade Agents

Gas

Arceole

Arceole SF6 enables a safe air/gas mixing ratio of 80/20 with an average tamponade duration of 10 - 15 days. Mainly used in retinal detachment without proliferative retinopathy and macular hole.



301

Qty: 1/Bx

Brand: ARCADOPHTA

Description	SKU #
Arceole SF6 Single Dose	301
Arceole Set Multidose SF6	311

Gas

Arceole

Arceole C2F6 enables a safe air/gas mixing ratio of 84/16 with an average tamponade duration of 30-35 days. Mainly used in retinal detachment without proliferative retinopathy and macular hole.



302

Qty: 1/Bx

Brand: ARCADOPHTA

Description	SKU #
Arceole C2F6 Single Dose	302
Arceole Set Multidose C2F6	312

Gas

Arceole

Arceole C3F8 enables a safe air/gas mixing ratio of 88/12 with an average tamponade duration of 55 - 65 days. Mainly used in retinal detachment without proliferative retinopathy and macular hole.



303

Qty: 1/Bx

Brand: ARCADOPHTA

Description	SKU #
Arceole C3F8 Single Dose	303
Arceole Set Multidose C3F8	313

Silicone Oil

Arciolane

Arciolane is a medical grade purified and fractionated silicone oil for prolonged tamponade of the retina in surgical treatment of severe retinal detachment. Compatible with most air pressure silicone oil injection systems thanks to ARC with a shelf life of 3 years.



201



Qty: 1/Bx

Brand: ARCADOPHTA

Description	SKU #
Arciolane 1300 10 ml vial	201
Arciolane 5500 10 ml vial	203
Arciolane 1300 10 ml syringe	202
Arciolane 5500 10 ml syringe	204
Arciolane 1300 15 ml syringe	205
Arciolane 5500 10 ml syringe - China	207

Tamponade Agents

Arciolane Accessories

ARC 510

Arciolane steady male/female air pressure connector compatible with Sto (Alcon).



Qty: 1/Bx
Brand: ARCADOPHTA

Description	SKU #
ARC 510 Luer Lock	510

ARC 520

Arciolane rotative air pressure connector compatible with: Constellation (Alcon), EVA (Dorc).



Qty: 1/Bx
Brand: ARCADOPHTA

Description	SKU #
ARC 520 Accurus	520

ARC 530

Arciolane rotative air pressure connector compatible with Stellaris PC (B&L).



Qty: 1/Bx
Brand: ARCADOPHTA

Description	SKU #
ARC 530 Millenium	530

ARC 540

Arciolane steady air pressure connector Compatible with: R-Evolution® (BVI), R-Evo smart® (BVI), Faros (Oertli) and Vitalis 500 (Zeiss).



Qty: 1/Bx
Brand: ARCADOPHTA

Description	SKU #
ARC 540 Orbit	540

Corneal Protection

Op'Cover

Op'Cover is intended to temporarily cover the patient's cornea with a protective film during an eye examination with a lens or during eye surgery. It avoids dehydration or abrasion of the cornea while maintaining its optical clarity.



Qty: 10/Bx
Brand: ARCADOPHTA

Description	SKU #
Op'Cover pack of 10	401



Product Index

SKU#	Description	PG	SKU#	Description	PG
0009701	5 mm Trepine Blade	14	113242	22G Flared phaco tip, 30 Degrees, Green	118
0009703	5.5 mm Trepine Blade	14	113250	20G Flared bent phaco tip, 30 Degrees, Blue	118
0009705	6 mm Trepine Blade	14	113251	21G Flared bent phaco tip, 30 Degrees, Yellow	118
0009706	6.25 mm Trepine Blade	14	113307	Silicone sleeve for 21G tips - (2.3 mm incision), Yellow	118
0009707	6.5 mm Trepine Blade	14	113308	Silicone sleeve for 20G tips - (2.8 mm incision), Blue	118
0009708	6.75 mm Trepine Blade	14	113309	Silicone sleeve for 22G tips - (1.8 mm incision), Green	118
0009709	7 mm Trepine Blade	14	113402	Phaco tip wrench	118
0009710	7.85 mm Trepine Blade	14	114101	Coaxial I/A hand-piece	119
0009711	7.5 mm Trepine Blade	14	114216	20G Straight I/A cannula with silicone sleeve, Blue	119
0009713	8 mm Trepine Blade	14	114217	20G Angled I/A cannula with silicone sleeve, Blue	119
0009715	8.5 mm Trepine Blade	14	114218	21G Straight I/A cannula with silicone sleeve, Yellow	119
0009717	9 mm Trepine Blade	14	114219	21G Angled I/A cannula with silicone sleeve, Yellow	119
0009719	7.25 mm Trepine Blade	14	114222	22G Straight I/A cannula with silicone sleeve, Green	119
0009721	10 mm Trepine Blade	14	114223	22G Angled I/A cannula with silicone sleeve, Green	119
0009722	7.75 mm Trepine Blade	14	114301	Bimanual I/A, Irrigation cannula	119
0009723	8.75 mm Trepine Blade	14	114302	Bimanual I/A, Aspiration cannula	119
0009725	11 mm Trepine Blade	14	115101	Diathermy bipolar cable	119
0009727	8.25 mm Trepine Blade	14	115301	Diathermy forceps	119
0009728	14 mm Trepine Blade	14	115302	Diathermy pencil eraser	119
102	Arcaline 5 ml vial	145	116002	EasySys reusable cassette	118
103	Arcaline 7 ml vial	145	116003	Sterilization tray for phaco and I/A hand-pieces	109
104	Arcotane 5 ml vial	145	116008	EasySys reusable cassette	118
105	Arcotane 7 ml vial	145	117001	Irrigation/aspiration tubing set	118
106	Arcaline 5ml vial - China Market	145	117004	Irrigation/aspiration tubing set	118
201	Arciolane 1300 10 ml vial	146	117006	EasySys reusable I/A cassette	118
202	Arciolane 1300 10 ml syringe	146	121012	R-Evolution® CR	107
203	Arciolane 5500 10 ml vial	146	121013	R-Evo Smart® CR	108
204	Arciolane 5500 10 ml syringe	146	122007	Remote control for R-Evolution® and R-Evolution® CR	109
205	Arciolane 1300 15 ml syringe	146	128910	Integrated endo-laser upgrade for R-Evolution® CR	107
207	Arciolane 5500 10 ml syringe - China	146	131002	Cryo-line	108
301	Arceole SF6 Single Dose	146	132008	Gas cylinder adapter	110
302	Arceole C2F6 Single Dose	146	132009	Gas cylinder adapter	110
303	Arceole C3F8 Single Dose	146	132010	Gas cylinder adapter	110
311	Arceole Set Multidose SF6	146	133002	Cryo probe for retina, Ball	110
312	Arceole Set Multidose C2F6	146	133004	Cryo probe for retina, "T" shaped	110
313	Arceole Set Multidose C3F8	146	133005	Cryo probe for retina, "Bonnet"	110
401	Op'Cover pack of 10	147	133006	Cryo probe for glaucoma	110
510	ARC 510 Luer Lock	147	143001	10 MHz Biometry probe	122
520	ARC 520 Accurus	147	143011	8 MHz Diagnostic A-Scan probe	122
530	ARC 530 Millenium	147	143016	Connecting cable for B-Scan probe	122
540	ARC 540 Orbit	147	143200	12 MHz B-Scan probe	122
602	Monoblue-ILM View	145	143300	20 MHz B-Scan probe	122
609	Monoblue-Dual View	145	143500	50 MHz B-Scan probe	122
615	Monoblue NafX	145	143600	35 MHz B-Scan probe	122
655	Monoblue SafR	145	149006	Cup for immersion biometry Ø 14 mm	122
8680	Weck-Cel® Spears, 6 Pack	56	149008	Cup for immersion biometry Ø 18 mm	122
8685	Weck-Cel® Spears, 10 Pack	56	149009	B-Scan cups kit for immersion 19/22/24 mm	122
37758	NuVisc™ Pro	144	153005	50 MHz Straight pachymetry probe	122
40810	UltraClean™ Eye Spears	56	161204	Keratron™ Scout	120
40815	UltraClean™ Eye Spears	56	161301	Keratron™ Piccolo	120
111009	R-Evo smart® E	108	161601	Keratron™ Nova	120
111010	R-Evo Smart® S	108	162202	Docking base for Keratron™ Scout	121
111012	R-Evolution®	107	162206	Slit lamp adaptor kit for Keratron™ Scout	121
112104	Foot-pedal, R-Evolution® and R-Evolution® CR	109	162211	Far mire cone for Keratron™ Scout/Keratron™ Piccolo	121
112105	Foot-pedal, R-Evo Smart® E, S and CR	109	163202	Base with joystick for Keratron™ Piccolo	109
113101	Phaco hand-piece - Slim 4	109	163204	Base with joystick for Keratron™ Nova	121
113107	Phaco hand-piece - Six	109	181006	Cart with integrated IV pole	109
113206	20G Standard phaco tip, 30 Degrees, Blue	118	181007	Irrigating solution continuity guard	109
113209	22G Standard phaco tip, 30 Degrees, Green	118	183001	Cart with gas cylinder holder	110
113217	Pars plana phaco tip	118	190700	Air controlled irrigation device	114
113237	21G Standard phaco tip, 30 Degrees, Yellow	118	191004	Kawano irrigation surge suppressor	114
113240	20G Flared phaco tip, 30 Degrees, Blue	118	191616	Screen cover and Mayo drape for R-Evo Smart®	114
113241	21G Flared phaco tip, 30 Degrees, Yellow	118	191702	Irrigation/aspiration kit for Pulsar	114

Product Index

SKU#	Description	PG	SKU#	Description	PG
191703	Irrigation/aspiration kit for Pulsar II Minimal Stress	114	370828	2.8 mm Slit, 45 Degrees, Double bevel up	8
191704	Irrigation/aspiration kit for Pulsar II Minimal Stress	114	370830	3 mm Slit, 45 Degrees, Double bevel up	8
192110	Backflush handpiece	117	371301	Blade wrench	15
192123	23G Soft tip cannula	117	371305	Collet replacement	15
192125	25G Soft tip cannula	117	371350	Round handle	15
192127	27G Soft tip cannula	117	371360	Round handle	15
192133	23G Blunt tip cannula	117	371394	Round handle	15
192135	25G Blunt tip cannula	117	371395	Round handle	15
192137	27G Blunt tip cannula	117	371410	Round handle	15
192223	23G Valved trocar kit	115	372000	Flat handle, 17 cm Long	15
192225	25G Valved trocar kit	115	372242	Swivel Fixation Ring	52
192227	27G Valved trocar kit	115	373025	2.5 mm Kojo Slit, 45 Degrees	7
192302	25G Vitreous cutter single blade	115	373032	3.2 mm Kojo Slit, 45 Degrees	7
192303	23G Vitreous cutter single blade	115	373328	2.8 mm Slit, Straight, Matte	8
192304	Anterior Vitrectomy Probe	115	373332	3.2 mm Slit, Straight, Matte	8
192313	23G Twedge™ dual blade vitreous cutter	115	373710	1 mm Sideport Knife, Angled	8
192315	25G Twedge™ dual blade vitreous cutter	115	373712	1.2 mm Sideport Knife, Angled	8
192317	27G Twedge™ dual blade vitreous cutter	115	373718	1.8 mm Slit, 45 Degrees, Single bevel up	8
192513	Air Injection Tube with Filter	116	373722	2.2 mm Slit, 45 Degrees, Single bevel up	8
192514	Two-ways stopcock	117	373724	2.4 mm Slit, 45 Degrees, Single bevel up	8
192516	Adapter for simultaneous connection	116	373725	2.5 mm Slit, 45 Degrees, Single bevel up	8
192518	Adapter syringe tubing	116	373726	2.6 mm Slit, 45 Degrees, Single bevel up	8
192519	Adapter syringe tubing LLF	116	373727	2.75 mm Slit, 45 Degrees, Single bevel up	8
192525	Viscous Fluid Removal Kit	116	373728	2.8 mm Slit, 45 Degrees, Single bevel up	8
192540	Silicone Oil Injection/Removal Kit	116	373730	3 mm Slit, 45 Degrees, Single bevel up	8
192550	Automatic BSS/Air infusion control system	116	373732	3.2 mm Slit, 45 Degrees, Single bevel up	8
192623	23G Endo Diathermy probe	115	373807	2.5 mm, 55 Degrees, Bevel up	8
192625	25G Endo Diathermy probe	115	373808	2.5 mm, 55 Degrees, Straight	8
192627	27G Endo Diathermy probe	115	373809	2.5 mm, 55 Degrees, Bevel down	8
192703	EasySys Irrigation/aspiration kit	114	374310	Round handle	15
192704	EasySys Irrigation/aspiration kit	114	374312	Round handle	15
192807	23G Standard probe	115	374320	Round handle	15
192808	25G Standard probe	115	374330	Hex handle	15
192816	23G Shielded wide angle probe	115	374340	Hex handle	15
192817	25G Chandelier with adjustable ring	115	374769	Mini-Blade Knife	9
192818	27G Standard probe	115	374881	15 Degrees, Straight, Green	13
192845	25G Shielded wide angle probe	115	374882	22.5 Degrees, Straight, Slate blue	13
195120	AGILE™ Phaco Pack 20G S	111	374883	30 Degrees, Black	13
195121	AGILE™ Phaco Pack 21G S	111	374890	15 Degrees, 30 Degree bend left	10
195220	AGILE™ Phaco Pack 20G F	111	374891	15 Degrees, Straight, Green	10
195221	AGILE™ Phaco Pack 21G F	111	374892	22.5 Degrees, Straight, Slate blue	10
195320	AGILE™ Phaco Pack 20G FB	111	374893	30 Degrees, Straight, Black	10
195321	AGILE™ Phaco Pack 21G FB	111	374894	45 Degrees, Straight, Tan	10
199123	23G Twedge™ VitPack SP	112	375000	Flat handle	15
199125	25G Twedge™ VitPack SP	112	375700	Sclerotome Blade	11
199127	27G Twedge™ VitPack SP	112	375701	Sclerotome Knife	9
199323	23G Twedge™ VitPack SH	112	376300	Mini-Blade, Sharp on two sides with pointed tip	11
199325	25G Twedge™ VitPack SH	112	376401	6400 Mini-Blade	12
221250	Wet-Field® Hemostatic Eraser Bipolar Bevel Tip	73	376620	1.15 mm Sideport, Angled	9
221251	Wet-Field® Hemostatic Eraser Bipolar Blunt Tip	73	376630	1.15 mm MVR, 20G, Straight	9
221260	Wet-Field® Hemostatic Eraser Bipolar Blunt Tip	73	377511	1.5 mm, 15 Degrees, Orange	13
221265	Wet-Field® Hemostatic Eraser Bipolar Tapered Tip	74	377512	1.5 mm, 15 Degrees, Orange	10
221266	Wet-Field® Hemostatic Eraser Bipolar Tapered Tip	74	377513	3 mm, 15 Degrees, Blue	13
221267	Wet-Field® Hemostatic Eraser Bipolar Fine Tip	74	377514	3 mm, 15 Degrees, Blue	10
221268	Wet-Field® Hemostatic Eraser Bipolar Fine Tip	74	377515	5 mm, 15 Degrees, Green	13
370145	2.5 mm Slit, Angled, Single bevel	6	377516	5 mm, 15 Degrees, Green	10
370146	2.6 mm Slit, Angled, Single bevel	6	377522	4 mm, 22.5 Degrees, Light blue	13
370820	2 mm Slit, 45 Degrees, Double bevel up	8	377523	4 mm, 22.5 Degrees, Light blue	10
370822	2.2 mm Slit, 45 Degrees, Double bevel up	8	377530	3.5 mm, 30 Degrees, Black	13
370824	2.4 mm Slit, 45 Degrees, Double bevel up	8	377531	3.5 mm, 30 Degrees, Black	10
370825	2.5 mm Slit, 45 Degrees, Double bevel up	8	377546	3 mm, 45 Degrees, Tan	10
370826	2.65 mm Slit, 45 Degrees, Double bevel up	8	378210	1 mm Sideport, Angled 45 degrees	7
370827	2.75 mm Slit, 45 Degrees, Double bevel up	8	378212	1.2 mm Sideport, Angled 45 degrees	7

Product Index

SKU#	Description	PG	SKU#	Description	PG
378214	1.4 mm Slit, Angled, Single bevel	6	581277	Anterior Chamber Cannula 16G	26
378215	1.5 mm Slit, Angled, Single bevel	6	581280	Anterior Chamber (Rycroft) 27G	19
378218	1.8 mm Slit, Angled, Single bevel	6	581281	Anterior Chamber (Rycroft) 21G	26
378220	2 mm Slit, Angled, Single bevel	6	581284	Anterior Chamber Cannula 27G	19
378222	2.2 mm Slit, Angled, Single bevel	6	581285	Anterior Chamber Cannula 30G	19
378224	2.4 mm Slit, Angled, Single bevel	6	581413	Eye Speculum	34
378227	2.75 mm Slit, Angled, Single bevel	6	581441	Visitec® Micro-Manipulator	43
378228	2.8 mm Slit, Angled, Single bevel	6	581442	Sinsky Hook Gen 2	43, 54
378230	3 mm Slit, Angled, Single bevel	6	581443	Eye Speculum Open Wire Loops	35
378231	1.15 mm 20G Sideport, Angled 45 degrees	7	581458	Jewellers Forceps	39
378232	3.2 mm Slit, Angled, Single bevel	6	581486	Capsulorhexis Forceps Grasping/Curved Tips - Gen 3	38
378233	0.6 mm 23G Sideport MVR	7	581488	Capsulorhexis Forceps Sharp/Curved Tips - Gen 3	38
378234	2.5 mm Crescent, 55 Degrees, Bevel up	7	581592	Nucleus Hydrodissector 30G	21
378235	15 Degree Sideport, Straight	7	581594	Irrigating Cystotome 23G	24
378236	22.5 Degree Sideport, Straight	7	581599	Irrigating Cystotome 23G	24
378237	30 Degree Sideport, Straight	7	581602	Irrigating Side Cutting Cystotome 25G	24
378238	45 Degree Sideport, Straight	7	581604	Capsule Polisher (Kratz) 21G	29
378820	2 mm Slit, Angled, Double bevel	6	581605	Capsule Polisher (Kratz) 23G	29
378822	2.2 mm Slit, Angled, Double bevel	6	581610	Irrigating Cystotome 25G	24
378824	2.4 mm Slit, Angled, Double bevel	6	581614	Capsule Polisher 21G	28
378825	2.5 mm Slit, Angled, Double bevel	6	581615	Lacrimal Cannula 21G	30
378826	2.65 mm Slit, Angled, Double bevel	6	581617	Irrigating Cystotome 25G	24
378827	2.75 mm Slit, Angled, Double bevel	6	581618	Irrigating Cystotome 27G	24
378828	2.8 mm Slit, Angled, Double bevel	6	581630	Irrigating Cystotome 30G	24
378829	2.85 mm Slit, Angled, Double bevel	6	581637	Retrolubar (Atkinson) 25G	18
378830	3 mm Slit, Angled, Double bevel	6	581638	Retrolubar (Atkinson) 23G	18
378832	3.2 mm Slit, Angled, Double bevel	6	581639	Anterior Chamber (Rycroft) 25G	19
581007	Superflex Extension Set	66	581641	Retrolubar (Sharp Atkinson) 25G	18
581019	Eye Shield (Left/Right)	66	581642	Anterior Chamber Cannula 25G	19
581030	Visitec® Bulk High Flow Filter	66	581645	Posterior Scraper (Simcoe) 23G	29
581040	Universal Eye Shield	66	581708	Universal Pediatric Eye Shield	66
581047	Visitec® Visiwipe Instrument Wipe	64	581709	LASIK Expanded Spear	56
581056	Visitec® Double Male Luer Adapter	32, 66	581729	Saline solution, 500 ml plastic bottle	144
581057	Corneal Marking Pad	50, 66	581730	Saline solution, 500 ml plastic bottle	144
581060	Absorbent Stick	64	581732	Saline solution, 500 ml glass bottle	144
581062	Visitec® Corneal Light Shield	57	581738	Saline solution, 500 ml plastic bag	144
581069	Visiswab Cotton Swabs	64	581761	LASIK Eye Spear - Orange	56
581076	Visitec® Visiwipe Adhesive Wipe	64	585001	Retrolubar/Peribulbar (Atkinson) 23G	18
581089	Sponge Eye	56	585003	Micro J Shape Cannula 25G	23
581098	Visitec® LASIK Eye Drain (Chayet)	63	585004	Irrigating Cystotome 25G	24
581146	Fluid Collection Bag with Wick	63	585005	Flexible Tip Cannula 27G	28
581147	Visitec® Eye Fluid Wick	63	585006	Anterior Chamber Cannula Straight 27G	19
581148	Fluid Collection Bag with Wick	63	585007	Viscoflow Formed 27G	26
581149	Plastic Incise Drape with Fluid Collection Bag	59	585008	Irrigating Cystotome 27G	24
581150	Non-Woven Incise Drape with Fluid Collection Bag	59	585009	Viscoflow Cannula 23G	26
581151	Plastic Aperture Drape with Fluid Collection Bag	59	585015	Nucleus Hydrodelineator (P. Koch) 25G	21
581152	Non-Woven Aperture Drape with Fluid Collection Bag	60	585016	Lacrimal Cannula	30
581153	Non-Woven Incise Drape with Channel Bag	60	585017	Flexible Tip Cannula 25G	28
581154	Mini Pre-Split Incise Drape	61	585018	Micro J Shape Cannula 27G	23
581155	Non-Woven Aperture Drape with Channel Bag	60	585019	Retrolubar, Curved (Atkinson/Straus) 25G	18
581156	Non-Woven Incise Drape with 2 Bags	58	585021	Subretinal Fluid Cannula (Grizzard)	139
581157	Full Body Aperture Drape with 2 Bags	58	585025	Anterior Chamber (Rycroft) 23G	19
581159	Mini Plastic Incise Drape	61	585026	Viscoflow Cannula 27G	26
581160	Mini Plastic Aperture Drape	62	585027	Peribulbar (Atkinson) 25G	18
581161	Mini Plastic Aperture Drape	62	585029	Micro J Shape Hydrodissector (Pearce) 27G	23
581162	Dual Refractive Drape	62	585030	Irrigating Cystotome (Joyce) 25G	25
581163	Full Body Incise Drape with Plastic Head	58	585031	Lacrimal Trephine (Sisler)	30
581164	Non-Woven Full Body Incise Drape	58	585033	Lacrimal Cannula (Shahinian)	30
581166	Non-Woven Half Body Incise Drape* with Channel Bag	61	585034	Irrigating Cystotome (Reverse) 25G	25
581177	Fluid Collection Bag	63	585036	Nucleus Hydrodissector (Pearce) 27G	21
581273	Anterior Chamber (Rycroft) 30G	19	585037	Nucleus Hydrodissector (Pearce) 25G	21
581275	Retrolubar (Sharp Point) 25G	18	585039	Irrigating Cystotome (Joyce) 27G	25
581276	Lacrimal Cannula 26G	30, 78	585040	Bishop Harmon Cannula 19G	26

Product Index

SKU#	Description	PG	SKU#	Description	PG
585041	Flexible Tip Cannula 23G	28	585250	LASIK Irrigating Cannula (Lindstrom)	31
585042	Irrigating Cystotome (Blumenthal) 27G	25	585252	LASIK Flap Spatula/Irrigator (Hersh)	31
585043	Irrigating Cystotome (Blumenthal) 27G	24	585271	LASIK Cannula (Daya)	31
585045	Viscoflow Cannula 25G	26	585274	Nucleus Hydrodissector (Pearce) 27G	21
585046	Viscoflow Cannula 30G	26	585278	LASIK Cannula	31
585047	I and A Cannula Thinwall (Simcoe)	28	585280	LASIK Irrigating Cannula (Solomon)	31
585049	Irrigating Formed Cystotome 25G	24	585294	Nucleus Hydrodissector (Chang) 27G	22
585061	Self Retaining ACM (Lewicky)	20	585295	Nucleus Hydrodissector (Chang) 27G	22
585062	IOL Manipulator Blunt Tip	43	585297	Plastic Locking Eye Speculum	34
585068	Lacrimal Cannula	30, 78	585831	Saline solution, 25 ml plastic bottle	144
585075	Cortex Extractor 23G	27	585833	Enriched Saline Solution	144
585077	Nucleus Rotator	43	587000	I-Ring® Pupil Expander, 6/Pk	54
585086	I and A Cannula (Simcoe)	28	587001	I-Ring® Pupil Expander, 1/Pk	54
585090	HydroExpression Cannula (Corydon) 25G	23	587002	Soft Tip Cannula	139
585091	HydroExpression Cannula (Corydon) 23G	23	587003	Soft Tip Cannula	139
585093	Irrigating Cystotome (Simcoe) 27G	25	8440000	Accu-Temp® Variable Temperature Cautery	72
585094	Eye Speculum (Kratz/Barraquer)	35	8441000	Accu-Temp® Low Temperature Cautery	72
585099	Nucleus Hydrodissector (Sauter) 27G	21	8442000	Accu-Temp® High Temperature Cautery	72
585106	Cortex Extractor 24G	27	8443000	Accu-Temp® High Temperature Cautery	72
585107	Tapered Hydrodelineator (Blumenthal) 25G	22	8444000	Accu-Temp® High Temperature Cautery	72
585108	Retrobulbar/Peribulbar (Atkinson) 25G	18	8445000	Accu-Temp® High Temperature Cautery	72
585109	Retrobulbar/Peribulbar (Atkinson) 27G	18	8446000	Accu-Temp® Variable Temperature Cautery	72
585110	I and A Cannula (Simcoe)	28	8590300	Visitec® Guibor Eye Bandage	66
585113	Irrigating Cystotome (Blumenthal) 25G	25	8590350	Guibor Canaliculus Intubation Set (CIS)	49
585115	Blunt Tip Irrigating Cystotome (Kellan) 25G	25	8590450	Canaliculus Intubation Set (CIS)	49
585124	Visitec® Punctal Dilator and Probe	51, 77	9550005	9.5 mm Trephine Blade	14
585133	Glaucoma Revision Pick 60 Degree (Lederer)	29	9550006	10.5 mm Trephine Blade	14
585135	Glaucoma Revision Pick 30 Degree (Lederer)	29	9550013	11.5 mm Trephine Blade	14
585143	Olive Tip Polisher	29	9550025	9.25 mm Trephine Blade	14
585144	Peribulbar (Atkinson) 23G	18	9550026	4 mm Trephine Blade	14
585145	Peribulbar (Atkinson) 27G	18	9550028	12 mm Trephine Blade	14
585147	Olive Tip Cannula	29	9550029	13 mm Trephine Blade	14
585148	Micro J Shape Cannula (Hessburg) 25G	23	22155010	Wet-Field® Disposable Cable Shrouded	74
585149	Oval ACM (Blumenthal)	20	221260135	Wet-Field® Hemostatic Eraser Bipolar Blunt Tip	73
585155	Nucleus Hydrodissector 27G	22	221260150	Wet-Field® Hemostatic Eraser Bipolar Blunt Tip	73
585157	Cortical Cleaving Hydrodissector (Round End) 27G	22	221267135	Wet-Field® Hemostatic Eraser Bipolar Fine Tip	74
585158	Cortical Cleaving Hydrodissector (Flat End) 27G	21	221268150	Wet-Field® Hemostatic Eraser Bipolar Fine Tip	74
585159	Cortical Cleaving Hydrodissector (Bolger) 25G	22	811011000	Dual Luer Connector	119
585163	ACM Micro Etched (Dahan)	20	OMR340833	Filter, passive protection for ZEISS and Moller microscopes	110
585173	High Viscosity Injector (Hammer)	139	OMR340846	Filter, passive protection for Leica microscopes	110
585176	Sub-Tenon's Anesthesia Cannula 19G	19	OMR340848	Filter, active protection for Leica microscopes	110
585181	Nucleus Chopper (P. Koch)	41	OMR340849	Filter, active protection for Zeiss and Moller microscopes	110
585191	HydroExpression Cannula (Corydon) 27G	23	OMR340897	Filter, passive protection for Topcon microscopes	110
585193	Cortex Extractor 23G	27	OMR340898	Filter, active protection for Topcon microscopes	110
585195	Nucleus Hydrodissector (Sinsky) 25G	21	OMR340990	Filter, passive protection for Topcon microscopes	110
585197	Cortical Cleaving Hydrodissector (Grabow) 30G	23	OMR640425	Protective goggles, wavelength 532 nm	110
585198	Hydrodissection Cannula (Akahoshi Style) 27G	23	199123-20G F	23G Twedge™ UniPack SP 20G F	113
585199	Nucleus Hydrodissector (Buratto) 25G	22	199123-20G FB	23G Twedge™ UniPack SP 20G FB	113
585200	FLACS Cannula (Schweitzer)	31	199123-21G F	23G Twedge™ UniPack SP 21G F	113
585203	Pediatric Eye Speculum	36	199123-21G FB	23G Twedge™ UniPack SP 21G FB	113
585205	Vitreoretinal Cannula	139	199323-20G F	23G Twedge™ UniPack SH 20G F	113
585208	High Viscosity Injector (Hammer)	139	199323-20G FB	23G Twedge™ UniPack SH 20G FB	113
585209	Micro Iris Hook	54	199323-21G F	23G Twedge™ UniPack SH 21G F	113
585213	Spatula PRK	49	199323-21G FB	23G Twedge™ UniPack SH 21G FB	113
585222	Bimanual Aspiration Cannula 23G	27	A14-200	Parasol® Pre-Loaded Punctal Occluders Sterile	76
585223	Bimanual Aspiration Cannula 21G	27	A14-201	Parasol® Pre-Loaded Punctal Occluders Sterile	76
585226	Soft Tip Cannula	139	A14-201QL	Parasol® Quickload Punctal Occluders Sterile	76
585227	Cortex Extractor 23G	27	A14-202	Parasol® Pre-Loaded Punctal Occluders Sterile	76
585229	Soft Tip Cannula	139	A14-202QL	Parasol® Quickload Punctal Occluders Sterile	76
585231	0.6 mm MVR, Straight	9	A14-203	Parasol® Pre-Loaded Punctal Occluders Sterile	76
585232	0.6 mm Stiletto	9	A14-203QL	Parasol® Quickload Punctal Occluders Sterile	76
585233	LASIK Flap Roller	48			
585240	1.1 mm MVR, Straight	9			

Product Index

SKU#	Description	PG	SKU#	Description	PG
A14-205QL	Parasol® Quickload Punctal Occluders Sterile	76	FC25.R06	Kuhn 45° Power Gripping 25G Reusable	127
A14-401	Micro Flow™ Punctal Occluders	77	FC25.R07	Shah X-tra Grip 25G Reusable	127
A14-402	Micro Flow™ Punctal Occluders	77	FC27.D03	ILM End-gripping 27G Single-Use	126
A14-403	Micro Flow™ Punctal Occluders	77	FC27.D05	Eckardt Endgripping 27G Single-Use	127
BEAVER6400	Rounded tip, Sharp on one side	12	FC27.D07	Shah X-tra Grip 27G Single-Use	127
BEAVER6600	Lamellar, Angled 60 degrees	12	FC27.R03	ILM End-gripping 27G Reusable	126
BEAVER6610	Lamellar, Straight, Smooth undersurface	12	FC27.R05	Eckardt Endgripping 27G Reusable	127
BEAVER6700	Smaller alternative to #15	12	FC27.R07	Shah X-tra Grip 27G Reusable	127
BEAVER6900	Straight, Sharp all around	12	FC2720	Flight Case for E4 Unit	105
BF00.D51	Backflush reservoirs, Passive	134	FC401655	Flight Case for E2 Unit	105
BF00.D52	Backflush reservoirs, Active	134	LF00.R01	Constellation® Light Source Adaptor	141
BF00.D53	Disposable tubing for active aspiration	134	LF00.R02	Stellaris® Light Source Adaptor	141
BF00.R01	Universal Backflush Instrument	134	LF00.R03	Geuder® Light Source Adaptor	141
BF00.R02	Universal Backflush Instrument with Luer-lock Connector	134	LF00.R04	Ruck® Light Source Adaptor	141
BF23.D01	Standard 23G Blunt backflush instrument	133	LF00.R05	DORC® Light Source Adaptor	141
BF23.D02	Standard 23G Brush backflush instrument	133	LF23.D01	23G Standard light fibers	136
BF23.D05	Retractable 23G Retractable brush backflush instrument	133	LF23.D02	23G Wide view light fibers	136
BF23.D07	Extendable 23G Silicone tipped backflush instrument	133	LF23.D03	23G 45 Degree shielded light fibers	136
BF23.D51	23G BF Blunt needles	134, 140	LF25.D01	25G Standard light fibers	136
BF23.D52	23G BF Brush needles	134, 140	LF25.D02	25G Wide view light fibers	136
BF25.D01	Standard 25G Blunt backflush instrument	133	LF25.D03	25G 45 Degree shielded light fibers	136
BF25.D02	Standard 25G Brush backflush instrument	133	LF27.D01	27G Standard light fibers	136
BF25.D05	Retractable 25G Retractable brush backflush instrument	133	LF27.D02	27G Wide view light fibers	136
BF25.D07	Extendable 25G Silicone tipped backflush instrument	133	LF27.D03	27G 45 Degree shielded light fibers	136
BF25.D51	25G BF Blunt needles	134, 140	LF29.D02	29G Spotlight Directional Chandelier	124
BF25.D52	25G BF Brush needles	134, 140	LG001	Diode Laser Safety Goggles	105
BF27.D01	Standard 27G Blunt backflush instrument	133	LP23.A04	Laser Probe 23G Compatible with Alcon®	130
BF27.D02	Standard 27G Brush backflush instrument	133	LP23.A05	Illuminated Laser Probe 23G Compatible with Alcon®	130
CN23.D01	23G Silicone tipped cannula	139	LP23.D04	Laser Probe 23G Compatible with DORC®	130
CN23.D03	23G VFI cannula	139	LP23.D05	Illuminated Laser Probe 23G Compatible with DORC®	130
CN23.D04	23G Pick needle	140	LP23.I04	Laser Probe 23G Compatible with Iridex® and B&L	130
CN23.D05	23G Blunt needle with luer-lock connector	134, 140	LP23.I05	Illuminated Laser Probe 23G Compatible with Iridex® and B&L	130
CN25.D01	25G Silicone tipped cannula	139	LP25.A04	Laser Probe 25G Compatible with Alcon®	130
CN25.D03	25G VFI cannula	139	LP25.A05	Illuminated Laser Probe 25G Compatible with Alcon®	130
CN25.D04	25G Pick needle	140	LP25.D04	Laser Probe 25G Compatible with DORC®	130
CN25.D05	25G Blunt needle with luer-lock connector	134, 140	LP25.D05	Illuminated Laser Probe 25G Compatible with DORC®	130
CN27.D03	27G VFI cannula	139	LP25.I04	Laser Probe 25G Compatible with Iridex® and B&L	130
CN27.D05	27G Blunt needle with luer-lock connector	134, 140	LP25.I05	Illuminated Laser Probe 25G Compatible with Iridex® and B&L	130
CT003	Operating room system cart	106	LP27.A04	Laser Probe 27G Compatible with Alcon®	130
EO-CAP-S	Endoscope Connector Caps	105	LP27.D04	Laser Probe 27G Compatible with DORC®	130
FC00.R03	Reusable Cleaning Adapter	128	LP27.I04	Laser Probe 27G Compatible with Iridex® and B&L	130
FC23.D02	Serrated Gripping 23G Single-Use	126	MD23.D01	23G PFC injection needle	140
FC23.D03	ILM End-gripping 23G Single-Use	126	MD25.D01	25G PFC injection needle	140
FC23.D04	Asymmetrical Gripping 23G Single-Use	126	MMK0303/1	Malosa® Suture Removal Pack 1	83
FC23.D05	Eckardt Endgripping 23G Single-Use	127	MMK037/1	Malosa® Oculoplastic Suture Pack 1	83
FC23.D06	Kuhn 45° Power Gripping 23G Single-Use	127	MMK041/3	Malosa® Corneal Suture Pack	81
FC23.D07	Shah X-tra Grip 23G Single-Use	127	MMK062	Malosa® Blepharoplasty Pack	84
FC23.R02	Serrated Gripping 23G Reusable	126	MMK072	Malosa® Oculoplastic Suture Pack 2	83
FC23.R03	ILM End-gripping 23G Reusable	126	MMK086	Malosa® Minor Oculoplastics Pack 1	82
FC23.R04	Asymmetrical Gripping 23G Reusable	126	MMK100/2	Malosa® Core LASIK Pack	80
FC23.R05	Eckardt Endgripping 23G Reusable	127	MMK106	Malosa® Sub-Tenons Pack 1	85
FC23.R06	Kuhn 45° Power Gripping 23G Reusable	127	MMK110/3	Malosa® Core Surface Treatment Pack	80
FC23.R07	Shah X-tra Grip 23G Reusable	127	MMK132	Malosa® Chalazion Pack 2	84
FC25.D02	Serrated Gripping 25G Single-Use	126	MMK133	Malosa® Chalazion Pack 1	84
FC25.D03	ILM End-gripping 25G Single-Use	126	MMK165	Malosa® Blepharoplasty Pack 2	84
FC25.D04	Asymmetrical Gripping 25G Single-Use	126	MMK178	Malosa® Minor Oculoplastics Pack 2	83
FC25.D05	Eckardt Endgripping 25G Single-Use	127	MMK250/2	Malosa® Phaco Pack 1	80
FC25.D06	Kuhn 45° Power Gripping 25G Single-Use	127	MMK261/2	Malosa® Vitrectomy Access Pack	85
FC25.D07	Shah X-tra Grip 25G Single-Use	127	MMK262/1	Malosa® Cryo and Buckle Access Pack	86
FC25.R02	Serrated Gripping 25G Reusable	126	MMK462/3	Malosa® Complete Corneal Cross-Linking Pack	81
FC25.R03	ILM End-gripping 25G Reusable	126	MMK470/1	Malosa® Basic IVT Pack 1	81
FC25.R04	Asymmetrical Gripping 25G Reusable	126	MMK471	Malosa® Basic IVT Pack 2	82
FC25.R05	Eckardt Endgripping 25G Reusable	127	MMK484	Malosa® Paediatric Retinal Exam Pack	85

Product Index

SKU#	Description	PG	SKU#	Description	PG
MMK877	Malosa® Core IVT Pack 1	82	MMSU1207S	Lester Hook	42
MMSU0068S	Straight Rampley	46	MMSU1209CS	Colibri Notched Forceps, Short with contoured clips	37
MMSU0085S	Epilation Forceps	39	MMSU1209S	Colibri Notched Forceps, Short	37
MMSU0214S	Stevens Tenotomy, Straight, Rounded	44	MMSU1210CS	Curved Tying Forceps with contoured clips	40, 78
MMSU0238S	Adson Forceps, Toothed	36	MMSU1210S	Curved Tying Forceps	40, 78
MMSU0241S	Adson Forceps, Non-Toothed	39	MMSU1211S	Westcott Scissors, Curved, Pointed	45
MMSU0244S	Iris Scissors, Curved, Pointed	44	MMSU1213S	Westcott Scissors Curved Dolphin Nose	45
MMSU0249S	Iris Scissors, Straight, Pointed	44	MMSU1214S	Westcott Scissors, Straight, Pointed	45
MMSU0277S	Moorfields Forceps	39	MMSU1221S	Phaco Chopper/Mushroom Manipulator	42
MMSU0279CS	St Martins Forceps with contoured clips	39	MMSU1229S	Braunstein IVT Marker 3.5/4	50
MMSU0279S	St Martins Forceps	39	MMSU1231S	Horizontal Chopper/Kuglen Hook	42
MMSU0283CS	Jewellers Forceps, Fine Angled with contoured clips	39	MMSU1243S	Troutman Needle-Holder	46
MMSU0283S	Jewellers Forceps, Fine Angled	39	MMSU1252S	Kratz-Barraquer Speculum	35
MMSU0286CS	Jewellers Forceps, Fine Straight with contoured clips	39	MMSU1253S	Kratz-Barraquer Speculum, Temporal	34
MMSU0286S	Jewellers Forceps, Fine Straight	39	MMSU1262S	Neonatal Speculum Small	36
MMSU0454S	Dressing Scissors, Straight, Pointed	44	MMSU1275S	Barraquer Speculum, Flat Blade	35
MMSU0455S	Dressing Scissors, Straight, Rounded	44	MMSU1276S	Braunstein IVT Marker 3.5/4, Green	50
MMSU1102S	Govan Manipulator	42	MMSU1277S	Pointed IVT Marker 3.5/4, Blue	50
MMSU1103S	Sinsky Hook	42	MMSU1278S	Paediatric Speculum, 3cm	36
MMSU1105S	Claw Chopper	41	MMSU1284S	Contact Lens Forceps	39
MMSU1108S	Phaco Chopper	41	MMSU1285S	Double Ended IVT Guide Pad	50
MMSU1110S	Corneal Needle-Holder	46	MMSU1287S	Kratz-Barraquer Speculum, Curved	35
MMSU1113S	Corneal Epithelium Spatula Flat	49	MMSU1290S	Mechanical Speculum, Open Blade (PC)	34
MMSU1114CS	Fine Notched Forceps, Short (Hoskins) with contoured clips	37	MMSU1294S	LASIK Flap Separator/Elevator Curved	47
MMSU1114S	Fine Notched Forceps, Short (Hoskins)	37	MMSU1295S	LASIK Flap Separator/Elevator Straight	48
MMSU1115S	Notched Forceps (Hoskins)	37	MMSU1297S	Reinstein Lenticule Separator	47
MMSU1115CS	Notched Forceps (Hoskins) with contoured clips	37	MMSU1417S	Golf Club Spud	51
MMSU1119S	Greens Chopper, Right Handed	41	MMSU1419S	Punctum Dilator/Lacrimal Probe	51
MMSU1123CS	Fine Toothed Forceps Short (Bonn) with contoured clips	36	MMSU1458S	Lebuisson Manipulator	42
MMSU1123S	Fine Toothed Forceps Short (Bonn)	36	MMSU1460CS	IOL Removal Forceps with contoured clips	37
MMSU1124CS	Toothed Forceps (Bonn) with contoured clips	36	MMSU1460S	IOL Removal Forceps	37
MMSU1124S	Toothed Forceps (Bonn)	36	MMSU1474S	Barraquer Speculum, Solid Curved (PC)	35
MMSU1125CS	Straight Tying Forceps with contoured clips	40	MMSU1475S	Barraquer Speculum, Solid Blade (PC)	35
MMSU1125S	Straight Tying Forceps	40	MMSU1479S	Barraquer Speculum, Solid 18 mm Blade (PC)	35
MMSU1127CS	Angled Tying Forceps (McPherson) with contoured clips	40	MMSU1488S	Mechanical Speculum Solid Blade	34
MMSU1127S	Angled Tying Forceps (McPherson)	40	MMSU1495S	Fixation Ring	52
MMSU1129CS	Colibri Toothed Forceps, Short with contoured clips	36	MMSU1567CS	MICS Capsulorhexis Forceps - Curved/Sharp with contoured clips	38
MMSU1129S	Colibri Toothed Forceps, Short	36	MMSU1567S	MICS Capsulorhexis Forceps - Curved/Sharp	38
MMSU1134S	Y Shape Corneal Marker	47	MMSU1568S	MICS Capsulorhexis Forceps - Straight/Sharp	38
MMSU1137S	Thornton Fixation Ring	52	MMSU1568CS	MICS Capsulorhexis Forceps with contoured clips	38
MMSU1140S	Vannas Scissors, Curved	45	MMSU1573CS	MICS Capsulorhexis Forceps - Curved/Grasping with contoured clips	38
MMSU1141S	Vannas Scissors, Straight	45	MMSU1573S	MICS Capsulorhexis Forceps - Curved/Grasping	38
MMSU1144S	Drysdale Manipulator	42	MMSU1577S	Intravitreal Injection Guide	50
MMSU1146CS	Lens Loading Forceps with contoured clips	40	MMSU1578S	Rampley Short	46
MMSU1146S	Lens Loading Forceps	40	MMSU1583S	Waqar Suture Removal Forceps	40
MMSU1149S	Chalazion Clamp, Oval	52	MMSU3015S	Barraquer Needle-Holder	46
MMSU1150S	Chalazion Clamp, Round	52	MON006	26 in Medical grade monitor	106
MMSU1152S	Mendez Gauge	50	MON007	17 in Medical grade high resolution monitor	106
MMSU1153S	ICL Manipulator	43	NC001-A	Endoscope Tip Protector	105
MMSU1157S	Chalazion Curette, Double, 1 mm/2 mm	52	OAK-0431/SMH	23G Endo laser, Straight, Blue	116
MMSU1158S	Chalazion Curette, Double, 2 mm/3 mm	52	OAK-0432/SMH	25G Endo laser, Straight, Orange	116
MMSU1172S	LASIK Flap Separator/Elevator (Seibel)	47	OAK-0433/SMH	27G Endo laser, Straight, Magenta	116
MMSU1177S	LASIK Flap Elevator Curved 8 mm	47	OAK-0435/SMH	23G Endo laser, Angled, Blue	116
MMSU1179S	Mushroom Manipulator	42	OAK-0436/SMH	25G Endo laser, Angled, Orange	116
MMSU1181S	Punctum Dilator, Fine/Medium	51, 78	OAK-0437/SMH	27G Endo laser, Angled, Magenta	116
MMSU1187S	Corneal Epithelium Spatula Round	49	OME170Z	17K Pixel video adapter for use with E2 Unit	106
MMSU1193S	Punctum Dilator/Seeker	51, 78	OME170ZMG	17K Pixel video adapter for use with E4 Unit	106
MMSU1196S	Epithelium Well	49	OME2000	E2 Ophthalmic Laser Endoscopy System	104
MMSU1197S	Epithelium Well	49	OME200HRA	Dual Function Ophthalmic Endoscope	105
MMSU1206S	LASIK Flap Separator and Elevator, Binder	47	OME200SMAEA	Triple Function Ophthalmic Laser Endoscope	104
			OME200SMAHRA	Triple Function Ophthalmic Laser Endoscope	104

Product Index

SKU#	Description	PG
OME200SMAHRVA	Triple Function Ophthalmic Laser Endoscope	104
OME200SMAHRXA	Triple Function Ophthalmic Laser Endoscope	104
OME200SMAHRXVA	Triple Function Ophthalmic Laser Endoscope	104
OME200SMAVA	Triple Function Ophthalmic Laser Endoscope	104
OME200SMAXA	Triple Function Ophthalmic Laser Endoscope	104
OME200SMAXVA	Triple Function Ophthalmic Laser Endoscope	104
OME230HRA	Dual Function Ophthalmic Endoscope	105
OME230SMAHRXA	Triple Function Ophthalmic Laser Endoscope	104
OME300ZMG	10K Video adapter with 532Nm and 810Nm filter	106
OME4000	E4 Ophthalmic Endoscopy System	104
SC23.D01	Vertical Micro Scissors 23G Single-Use	128
SC23.D02	Straight Micro Scissors 23G Single-Use	128
SC23.D03	Horizontal Curved Micro Scissors 23G Single-Use	128
SC23.R01	Vertical Micro Scissors 23G Reusable	128
SC23.R02	Straight Micro Scissors 23G Reusable	128
SC23.R03	Horizontal Curved Micro Scissors 23G Reusable	128
SC25.D01	Vertical Micro Scissors 25G Single-Use	128
SC25.D02	Straight Micro Scissors 25G Single-Use	128
SC25.D03	Horizontal Curved Micro Scissors 25G Single-Use	128
SC25.R01	Vertical Micro Scissors 25G Reusable	128
SC25.R02	Straight Micro Scissors 25G Reusable	128
SC25.R03	Horizontal Curved Micro Scissors 25G Reusable	128
SC27.D01	Vertical Micro Scissors 27G Single-Use	128
SC27.D03	Horizontal Curved Micro Scissors 27G Single-Use	128
SC27.R03	Horizontal Curved Micro Scissors 27G Reusable	128
TM23.D01	23G Retractable tissue manipulator	140
TM25.D01	25G Retractable tissue manipulator	140
VL00.D01	Vitrectomy lens flat style	138
SW002	Footswitch with illumination and laser control	106
SW003	Footswitch for laser only	106
VL00.D02	Vitrectomy lens biconcave style	138
VL00.D03	Vitrectomy lens magnifying style	138
VL00.D04	Vitrectomy lens wide view style	138
VL00.D05	Vitrectomy lens 30° prism style	138
VP6250	Sterilization tray	106
VS00.R02	Williamson Scleral Depressor	142
ANKORIS TORIC		95
FINEVISION HP G-FREE		90
FINEVISION HP TORIC G-FREE		88
FINEVISION MICRO F		91
FINEVISION POD F		92
FINEVISION TORIC		89
ISOPURE 123 G-FREE		93
MICROPURE 123 G-FREE		96
MICROPURE G-FREE		97
PODEYE G-FREE		98
PODEYE TORIC G-FREE		94

BVI[®] is refocusing the future of vision.

As one of the fastest-growing, diversified surgical ophthalmic businesses in the world, our purpose-built portfolio spans more than 115 countries.

We've set our sights on touching the lives of millions of patients affected by conditions such as cataracts, refractive error, glaucoma, retinal disease, and dry eye.

Unburdened by legacy or bureaucracy, we have developed our strategy around a simple concept — taking pride in delivering innovative solutions for our physicians and patients, based on their needs.

We trust and empower our associates to make decisions and solve problems because collaboration drives us. Valuing agility, simplicity, and transparency, we stay committed to listening to our customers, delivering for our patients, and keeping the future in focus.



THE FUTURE IN FOCUS

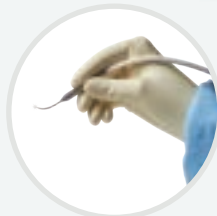

Beaver®
Knives and Blades

Visitec®
Cannulas

Malosa®
Single-Use Instruments

CustomEyes®
Custom Procedure Packs

Vitrea
Vitreoretinal Surgical Products

EndoOptiks®
Microendoscopy

ISOPURE®
Premium Monofocal IOLs

R-EVOLUTION
Ophthalmic Equipment

R-EVOSmart
Ophthalmic Equipment

BVI
Email: customersupport@bvimedical.com



BVI
bvimedical.com

BVI and all other trademarks (unless noted otherwise) are property of BVI. BVI ©2021-2023

1594865-01 IN